

**Personal Video Recorder  
Digital Terrestrial Receiver**

**Free-To-Air**

**PVR-8100T**

**User's Manual**



**HUMAX**  
your prime time

# Notice

## **Copyright** (Copyright © 2001 HUMAX Corporation)

Not to be copied, used or translated in part or whole without HUMAX's prior consent in writing except approval of ownership of copyright and copyright law.

## **Warranty**

HUMAX does not have any responsibility for direct, indirect, accidental, necessary and other damage due to your offer or use of the information contained in this manual.

## **Trademarks**

VIACCESS™ is a trademark of France Telecom.

CryptoWorks (TM) is a trademark of Philips Electronics N.V.

Irdeto is a trademark of Mindport BV.

Nagravision is a registered trademark of KUDELSKI S.A.

Conax is a trademark of Telenor Conax AS.

'Dolby' and the double-D symbol are trademarks of Dolby Laboratories.

Manufactured under license from Dolby Laboratories.

Thank you for purchasing a HUMAX digital terrestrial receiver and personal video recorder. Please read this user manual carefully, to be able to safely install, use and maintain the receiver at maximum performance. Keep this user manual next to your receiver for future reference. The information in this document is subject to change without notice

# Notice

Read this manual carefully and make sure you understand the instructions provided. For your safety, check what the result of each action will be.

## Warnings, Cautions and Notes

Throughout the whole manual, pay special attention to the following marks that indicate hazardous situations.

- **Warning**

Indicates a hazardous situation which, if not avoided, could result in (serious) injury.

- **Caution**

Indicates a situation which, if not avoided, could damage the equipment or other apparatus.

- **Note**

Indicates additional information to the user to make the user aware of possible problems and information of any importance to help the user to understand, to use and to maintain the installation.



To reduce the risk of electric shock, do not remove cover (or back). No user serviceable parts inside. Refer servicing to qualified service personnel.

This symbol indicates **dangerous voltage** inside the product that presents a risk of electric shock or personal injury.

This symbol indicates important instructions accompanying the product.

# Safety and Warning

This digital terrestrial receiver and personal video recorder has been manufactured to comply with international safety standards. Please read the following safety precautions carefully.

## Safety Instructions and Precautions

### 1. MAINS SUPPLY

90 - 250V AC 50/60Hz

Operate this product only from the type of power supply indicated on the marking label. If you are not sure of the type of power supplied to your home, consult your local power company. Disconnect the product from the mains before you start any maintenance or installation procedures.

### 2. OVERLOADING

Do not overload a wall outlet, extension cord or adapter as this may result in electric fire or shock.

### 3. LIQUIDS

The receiver should not be exposed to any liquids such as dripping or splashing. In addition, no objects filled with liquids, such as vase, shall be placed on the apparatus.

### 4. CLEANING

Disconnect the receiver from the wall outlet before cleaning. Use a light damp cloth (no solvents) to dust the receiver.

### 5. VENTILATION

The slots on top of the receiver must be left uncovered to allow proper airflow to the unit. Do not stand the receiver on soft furnishings or carpets. Do not stack electronic equipments on top of the receiver.

### 6. ATTACHMENTS

Do not use any unsupported attachments as these may be hazardous or cause damage the receiver.

### 7. CONNECTION TO THE AERIAL

Disconnect the receiver from the mains before connecting or disconnecting the cable from the aerial. Failure to do so can damage the aerial.

### 8. CONNECTION TO THE TV

Disconnect the receiver from the mains before connecting or disconnecting the cable from the aerial. Failure to do so can damage the TV.

### 9. EARTHING

The aerial cable must be buried in the ground.  
The buried cable of the system must comply with SABS 061.

# Safety and Warning

## 10. LOCATION

Place the receiver indoors to avoid exposing it to lightening, rain or sun.

Do not place it near a radiator or heat register.

Make sure it has more than 10 cm clearance from any appliances susceptible to electromagnetic influences, such as TV and VCR.

Do not block these openings with any object, and do not place the product on a bed, sofa, rug, or other similar surface.

If you place the product on a rack or bookcase, ensure that there is adequate ventilation and that you have followed the manufacturer's instructions for mounting.

Do not place the product on an unstable cart, stand, tripod, bracket, or table where it can fall.

A falling product can cause serious injury to a child or adult, and serious damage to the appliance.

## 11. LIGHTNING, STORM, or NOT IN USE

Unplug the product from the wall outlet and disconnect the aerial during a lightning storm or when left unattended and unused for long periods of time. This will prevent damage to the unit due to lightning and power-line surges.

## 12. EXTRANEIOUS OBJECTS

Do not insert anything through the openings in the unit, where they can touch dangerous voltage point or damage parts.

## 13. REPLACEMENT of PARTS

When the replacement parts are required, be sure the service technician uses replacement parts specified by the manufacturer or those that have the same characteristics as the original part. Unauthorised substitutions may result in additional damage to the unit.

## Warning

1. Follow these directions in order not to damage the power cord or plug.  
Do not modify or process the power cord or plug arbitrarily. Do not bend or twist the power cord too much. Make sure to disconnect the power cord with the plug held.  
Keep heating appliances as far as possible from the power cord in order to prevent the cover vinyl from melting.
2. Follow these directions. Failure to follow one of them may cause electrical shock.  
Do not open the main body. Do not insert metals or inflammable objects inside the product. Do not touch the power plug with a wet hand.  
Disconnect the power cord in case of lightening.
3. Do not use the product when it is out of order. If you continue to use the product when defective, serious damage can be caused to it. Make sure to contact your local product distributor if the product is out of order.
4. Please do not insert metal or alien substance into the slots for the modules and smart cards. In doing so can cause damage to the STB and reduce its life span.
5. Hard Disk Drive  
Do not move the product or turn the power off suddenly while the hard disk drive is running. The company shall not be liable for any corruption of data on the hard disk drive caused by the carelessness or misuse of users.  
Do not separate the hard disk drive from the main body.

<b>1. Before Using the Receiver</b>	<b>GB8</b>
1.1 Package Contents	GB8
1.2 Front Panel	GB9
1.3 Rear Panel	GB10
1.4 Remote Control	GB11
<b>2. Setup</b>	<b>GB14</b>
2.1 Connecting Aerial	GB14
2.2 Powering On	GB17
<b>3. Installation Wizard</b>	<b>GB18</b>
3.1 Language	GB18
3.2 Area Setting	GB18
3.3 Antenna Setting	GB19
3.4 Time Setting	GB19
<b>4. Basic Operation</b>	<b>GB20</b>
4.1 Switching Channel	GB20
4.2 Volume Control	GB20
4.3 Teletext	GB20
4.4 Changing the Subtitle Language	GB22
4.5 Changing a Audio Language	GB22
4.6 Programme Information (I- plate)	GB23
4.7 Option List	GB25

<b>5. Time Shifted Recording</b>	<b>GB27</b>
5.1 Time Bar	GB27
5.2 Pause	GB27
5.3 Fast Rewind to Previous Scene	GB28
5.4 Fast Forward to the Next Scene	GB28
5.5 Slow Motion	GB28
5.6 Recording	GB28
5.7 Additional Time Shift Operations using Time Bar	GB29
<b>6. Recording and Playback</b>	<b>GB30</b>
6.1 Instant Recording	GB30
6.2 Recording Reservation	GB30
6.3 Programme Playback	GB32
6.4 Editing Recorded Programmes	GB33
6.5 Checking Hard Disk Drive	GB34
<b>7. Channel List</b>	<b>GB35</b>
7.1 Displaying and Switching Channel List	GB35
7.2 Changing Channel List Group	GB36
7.3 Edit Channels	GB37
7.4 Edit Favourite Channels	GB41
7.5 Channel Change Mode	GB44
<b>8. Programme Guide</b>	<b>GB45</b>
8.1 Viewing Programme Guide Information	GB45
8.2 Finding a Programme	GB47
8.3 Viewing Reserved Programme	GB48

<b>9. Setting Preferences</b>	<b>GB50</b>
9.1 Parental Control	GB50
9.2 Language Setting	GB52
9.3 Time Setting	GB54
9.4 A/V Control	GB55
9.5 UHF Tuning	GB57
9.6 Miscellaneous Settings	GB58
<b>10. Installation</b>	<b>GB59</b>
10.1 Automatic Search	GB59
10.2 Manual Search	GB60
10.3 Default Setting	GB61
10.4 Antenna Power	GB62
<b>11. Software Update</b>	<b>GB63</b>
11.1 OTA (Over the Air)	GB63
11.2 S/W Update from PC	GB67
<b>12. System Information</b>	<b>GB68</b>
12.1 Status	GB68
12.2 Signal Detection	GB68
<b>13. Games</b>	<b>GB69</b>
<b>14. Manipulating your TV using Remote Control</b>	<b>GB70</b>
<b>15. Menu Map</b>	<b>GB79</b>
<b>16. Trouble Shooting</b>	<b>GB80</b>
16.1 Trouble Shooting	GB80
16.2 Error Message	GB81
<b>17. Specification</b>	<b>GB82</b>
<b>18. Glossary</b>	<b>GB84</b>
<b>19. Service and Support</b>	<b>GB85</b>

# 1.Before Using the Receiver

This chapter describes detail instructions on the product and its accessories.

## 1.1 Package Contents

Please check all package contents before using your product.



**Remote Control**



**User's Manual**



**Batteries**



**RF Cable**

### **Note:**

- Since faults may occur if the remote controller is being left without a battery for a long time, always keep the battery inserted in the remote controller.
- An active antenna is not included in a package.

**Warning:** To install a hard disk drive, contact your product provider.

The company shall not be liable for problems caused by installing a hard disk drive by user.

This product provides best performance with Seagate ST340015ACE (40GB), or Maxtor 2F040L0 (40GB) hard disk drive.

This product provides up to 80GB of hard disk drive. The company shall not be liable for problems caused by the installation of hard discs bigger than 80GB.

## 1.2 Front Panel

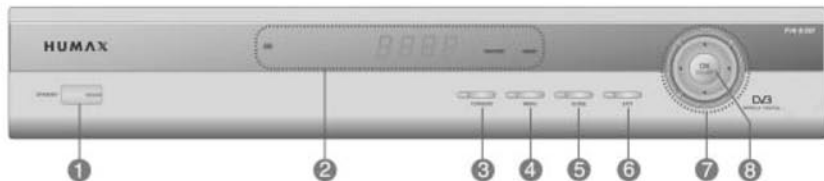

### 1. STANDBY Button

Switches between Operation and Standby modes.

### 2. Sensor, Display and LED

#### IR

Infrared remote control command indicator. This indicator lights up momentarily when a command from the handset is received.

#### Digit LED Display

This will display the current channel or certain programming functions when using the menus.

#### RECORD LED

Indicates that the STB is in recording mode.

#### RADIO LED

Indicates that the STB is in radio mode.

### 3. TV/RADIO Button

Switches between TV and Radio.

### 4. MENU Button

Displays the main menu.

### 5. GUIDE Button

Displays the Programme Guide.

### 6. EXIT Button

Exits the main menu or Guide screen.

### 7. ARROW Buttons

Changes the channel or move the cursor to the up, down, left or right menu option.

### 8. OK/CH.List Button

Selects a menu or confirms the selected operation. Displays the channel list while watching a programme.

# 1. Before Using the Receiver

## 1.3 Rear Panel

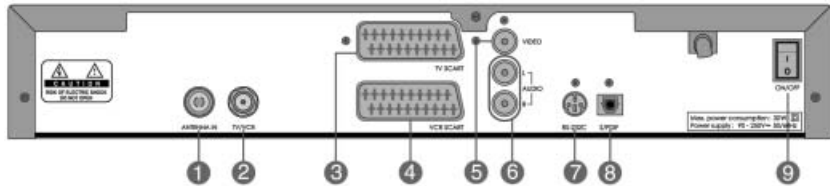

### 1. ANTENNA IN

Connects an Aerial to an Antenna input jack on the receiver.

### 2. TV / VCR

Connects a RF signal from your receiver to RF (ANT) input jack on your TV or VCR.

### 3. TV SCART

Connects to a TV using SCART cable.

### 4. VCR SCART

Connects to a VCR using SCART cable.

### 5. VIDEO

Connects to your TV or VCR using RCA cable to output Video signals.

### 6. AUDIO L/R

Connects to your TV or VCR using RCA cable to output Audio signals.

### 7. RS-232C

Connects to your PC to update product's software.

### 8. S/PDIF

Connects to a Digital Amplifier to output Digital Audio signals.

### 9. ON/OFF

Power on/off.

## 1.4 Remote Control

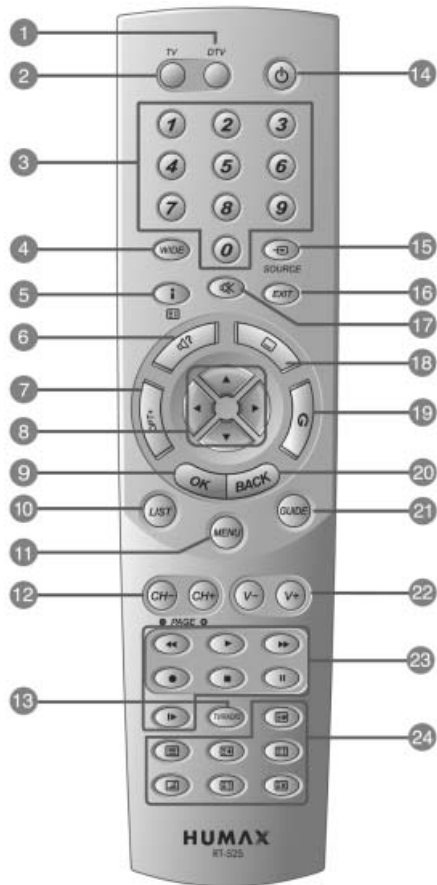

**Note:** This remote control can also control your TV. To set the remote control for your TV, please refer to Chapter 12. In TV mode, the STANDBY, AUX, NUMERICAL(0-9), CH-/CH+, V-/V+, MUTE buttons are supported.

# 1. Before Using the Receiver

- 1. DTV**  
Controls the receiver.
  - 2. TV**  
Controls the TV.
  - 3. NUMERICAL BUTTONS**  
Enter a TV/Radio channel number or menu option number.
  - 4. WIDE**  
Changes the display format.
  - 5. i (INFORMATION/INDEX)**  
Displays the information about the channel and programme in normal viewing mode. Moves to the index page in teletext mode.
  - 6. SOUNDTRACK**  
Displays the soundtrack list.
  - 7. OPT+ (OPTION)**  
Displays the channel attributes during watching a programme.
  - 8. ARROW BUTTONS**  
Changes the channel or move the cursor to the up, down, left or right menu option.
  - 9. OK**  
Selects a menu, or confirms the selected operation. And displays the channel list during watching a programme.
  - 10. LIST**  
Displays the channel list.
  - 11. MENU**  
Displays the main menu.
  - 12. CH- / CH+ and PAGE- / PAGE+**  
Changes the Channel or Page.
  - 13. TV/RADIO**  
Switches between TV and Radio modes.
  - 14. STANDBY**  
Switches between Operation and Standby modes.
  - 15. AUX/SOURCE**  
Controls the input of TV in TV mode. Selects the output source of the receiver in DTV mode.
  - 16. EXIT**  
Exits all On-Screen Display (OSD) screens.
  - 17. MUTE**  
Pauses the audio temporarily. That is, volumes on/off temporarily.
  - 18. SUBTITLE**  
Displays the subtitle language list.
  - 19. G (Game)**  
Displays the Game.
  - 20. BACK**  
Returns to the previous menu and screen.
  - 21. GUIDE**  
Displays the Programme Guide.
  - 22. V- / V+**  
Adjusts the audio volume.
- \*\* COLOUR BUTTONS**
- Selects the corresponding colour option displayed on the screen.

## 23. PLAYBACK CONTROL BUTTONS

 **(FAST REWIND)**

Rewinds a programme. Each time you press this button, the scenes is rearound more faster divided into 3 steps.

 **(PLAY)**

Plays a programme.

 **(FAST FORWARD)**

Fast forwards a programme. Each time you press this button, the scenes is forwarded faster divided into 3 steps.

 **(RECORD)**

Records a programme.

 **(STOP)**

Stops a programme and jump to alive programme.

 **(PAUSE)**

Pauses a programme.

 **(SLOW MOTION)**

Plays the programme in slow motion mode.

## 24. TELETEXT

 **(SUB-PAGE)**

Search the sub-page in teletext mode. If it's not in the teletext mode, display the current time.

 **(TELETEXT ON/OFF)**

Switches between Teletext and TV modes.

 **(DOUBLE)**

Displays the text size as double size.

 **(HOLD)**

Holds the current page not updating it.

 **(MIX)**

Adjusts transparency of teletext screen.

 **(REVEAL)**

Displays the concealed information.

 **(CANCEL)**

Hides the teletext except page number.

## 2. Setup

This chapter describes how to set up the receiver. Select the most appropriate procedure depending on your requirements.

**Note:** If you encounter any problem when setting up the receiver, please contact your local product distributor.

### 2.1 Connecting the Aerial

#### 1. Connecting TV and VCR

Connect the cable of your TV aerial to the **ANTENNA IN** connector on the rear of the receiver. The Aerial cable, RF cable, and Scart cable are connected as in the figure below.

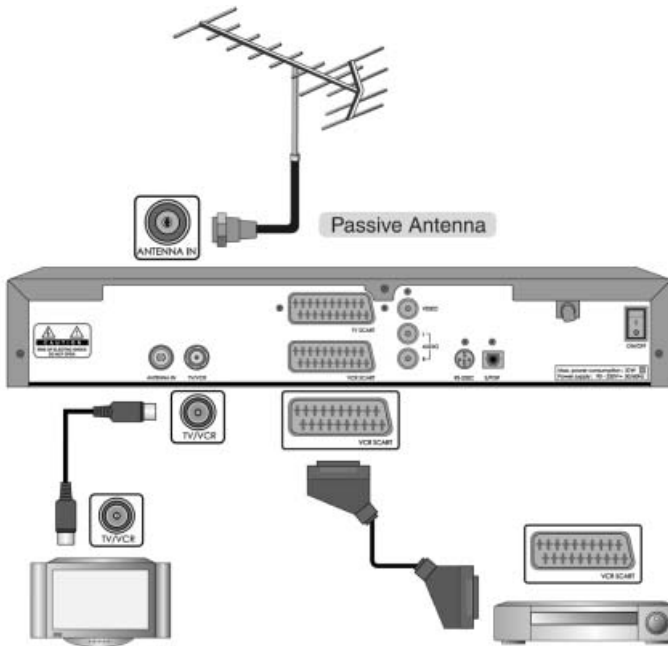

**Warning:** Make sure to set **Installation - Antenna Power** to **Off** before connecting to the antenna when passive antenna is used. The antenna can cause damages if you try to connect to the passive antenna when **Antenna Power** is set to **On**. Refer to Chapter 10.4 for more information.



## 2. Setup

### 3. Connecting Hi-Fi system 2

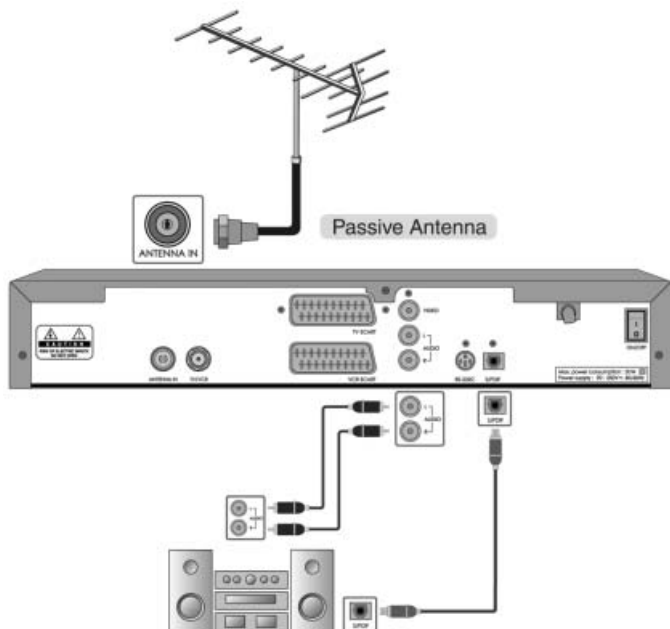

If you wish to connect the optical S/PDIF terminal and Dolby digital decoder to listen digital audio, connect as following.

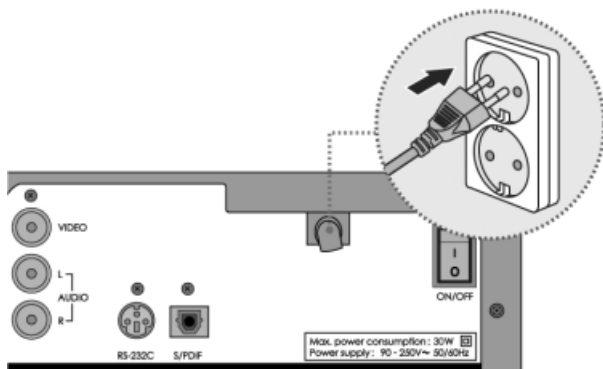

## 2.2 Powering On

1. Connect the power cord of the receiver to a wall outlet.  
Turn on the power switch, located at the left on the back of the receiver.  
Make sure that the Standby LED indicator is turned on Red.





2. Press the **DTV** (  ) button to control the receiver using the remote controller.
3. Press the **STANDBY** (  ) button on the Remote Controller or on the receiver.



## 3. Installation Wizard

When powering on your receiver for the first time after purchasing, the Installation Wizard is automatically started. You can easily set-up using simple organisation and options, and watch the broadcasting after completing the set-up procedure.

**Note:** If you press the **BACK** (  ) button or select **Back** and press the **OK** (  ) button while running the Installation Wizard, you can return to the previous screen.

### 3.1 Language

Select the appropriate language from the list using the ▲/▼ button and press the **OK** (  ) or ► button to save the selected language as a default language.

**Note:** The display language could be different according to country.



### 3.2 Area Setting

You can select area.

Select the appropriate area from the list using the ▲/▼ button and press the **OK** (  ) or ► button.

Select **Next** using the ▲/▼ button and press the **OK** (  ) button to go to the next step.



### 3.3 Antenna Setting

You can set the antenna power.

Press the **OK** (  ) or **▶** button to select **On or Off**.

**On** 5V power supply from the active antenna cable.

**Off** No power supply.

Select **Next** using the **▲/▼** button and press the **OK** (  ) button to start **Automatic Search**.

Please wait for finishing the Automatic Search. If you want to stop the Automatic Search, press the **OK** (  ) button.



If the Automatic Search is stopped or finished, you must press **Save** to save the searched result and go to the next step.



### 3.4 Time Setting

You can set the current time.

Press the **OK** (  ) or **▶** button to display the values for **GMT Offset**.

Select the appropriate GMT Offset value using the **▲/▼** button and press the **OK** (  ) button to set the current time. Then select **Next** using the **▲/▼** button and press the **OK** (  ) button to finish Installation Wizard.

**Note:** The default item is **Auto**. If GMT Offset is Auto, it is automatically set depending on your country. However, if the time is NOT set properly, you can change GMT Offset to fit your local time.

**Warning:** Press the **EXIT** (  ) button to save the previous input information and exit the Installation Wizard when running the Installation wizard.





## 4. Basic Operation

This chapter describes functions such as switching channel, volume control, and basic features for watching programmes.



### 4.1 Switching Channel

You can switch the current channel using one of the following methods.

1. Press the **CH-/CH+** (  ) button.
2. Enter your desired channel numeric using the **NUMERICAL** (0-9) buttons to move to the channel directly.
3. Press the **TV/RADIO** (  ) button to switch between TV channel and Radio channel.

**Note:** You can switch channel using the Channel List or Programme Guide. Please refer to Chapter 7 and 8 for more information.

### 4.2 Volume Control





1. Press the **V-/V+** (  ) buttons to adjust the audio volume.
2. Press the **MUTE** (  ) button to stop the sound temporarily.

**Note:** The mute function keeps enabled while you change the channel.

### 4.3 Teletext







When the channel supports teletext, the teletext icon (  ) is displayed on the I-plate. To enter Teletext mode, press the **TELETEXT ON/OFF** (  ) button or the **SUBTITLE** (  ) button to display teletext.

#### 1. Using Teletext Menu

1. Press the **MENU** (  ) button to display teletext menu in teletext mode.
2. Select your desired teletext function using the   button.
3. Press the **OK** (  ) button.



## Teletext Functions

	<b>Index</b>	Return to index page. If there is no index page, jump to page 100.
	<b>Sub-page</b>	Search the sub-page using the sub-code written by users. If it's not in the teletext mode, display the current time.
	<b>MIX</b>	Adjusts transparency of teletext screen.
	<b>Cancel</b>	Hides the teletext except page number.
	<b>Reveal</b>	Displays the concealed information.
	<b>Double Size</b>	Displays the text size as double size.
	<b>Page Hold</b>	Holds the current page not updating it.

## 2. Viewing Teletext Page





1. Enter your desired page number using the **NUMERICAL** (0~9) buttons to move to the page directly.
2. Press the ▲ button to move to the next page in increased number.
3. Press the ▼ button to move to the previous page in decreased number.
4. Press the **CH-/CH+** (⊖/⊕) buttons to move to previous/next page.
5. Press the **BACK** (⏪) button to move back up to 7 recently viewed pages in sequence.



## 4. Basic Operation

### 4.4 Changing the Subtitle Language

If the current programme provides Subtitle information, you can select the language for the Subtitle.





1. Press the **SUBTITLE** (  ) button to display the subtitle language list.
2. Select your desired subtitle language using the / button, and press the **OK** (  ) button. Then the subtitle will be displayed in the selected language at the bottom of the screen.
3. Select **OFF** from the subtitle language list not to display subtitle from the screen.



**Note:** You can select a default subtitle language by selecting **MENU - Preferences - Language Setting - Subtitle Language**.

### 4.5 Changing a Audio Language

If the current programme is available in multiple audio languages, you can select the language that you wish to listen in.



1. Press the **SOUNDTRACK** (  ) button to display **soundtrack list**.
2. Select your desired audio language using the / button to change Audio immediately.
3. Select Audio Direction(left, right, stereo) using the / button.



**Note:**

- You can select your desired default audio language by selecting **MENU - Preferences - Language Setting - Audio Language**.
- If the programme is Dolby digital one, you cannot set the audio direction such as left, right, and stereo.

## 4.6 Programme Information (I- plate)

Programme information is displayed for a specific period of time whenever you switch channels. You can view the programme information by pressing the **i** (  ) button while watching a programme. Press the **EXIT** (  ) button to hide the I-plate.

### 1. General Information

General Information is displayed as follows on the screen.

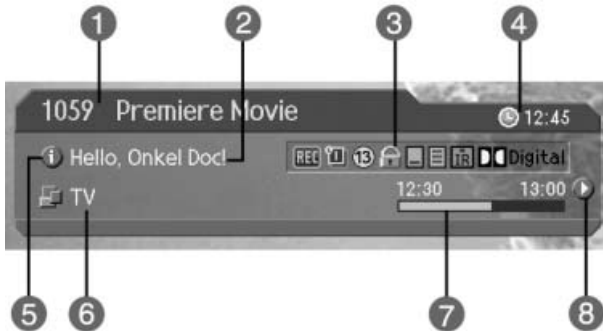

1. Channel number and channel name
2. Programme name
3. Icons



Displayed only if this programme is recording.



Displayed only if this programme is reserved.



Represents parental level. It indicates the minimum level of ages that the programme is targeted at.



Displayed only when the channel is a locked channel.



Displayed only when the channel is a scrambled channel.



Displayed only when subtitle information is available.



Displayed only when there is any teletext information.



Displayed only when the programme is a dolby digital one.

## 4. Basic Operation

4. Current time
5. Detail programme information: displayed if detailed programme information is provided.
6. Channel looping mode and Channel List Name : if you select **Within the current channel list** by selecting **MENU - Edit Channels - Channel Change Mode**, the Icon of Channel looping mode is displayed. And channel list, which you selected, is displayed.
7. Programme broadcasting time and progress bar: displays programme playing time and progress bar.
8. Next programme Information : displayed if next programme information is provided. Press the **▶** button to display the next programme information.

**Note:** If there is no available programme information, programme information is not displayed.

## 2. Detailed Programme Information

You can see detailed information about the current programme. Press the **i (i)** button where I-plate is displayed to view detailed information.

**Note:**

- Press the **i (i)** button again to hide the information box.
- If the Detailed programme information is more than one page, use the **▲/▼** button to move to the previous or next page.







## 4.7 Option List

You can view and confirm detailed information about the current channel and change the information in necessary.

**Note:** Press the **OPT+** (  ) button when the channel list is displayed to view **Option List**. Then the following functions in the option list are performed to the current channel where cursor is located.

### 1. Add a channel to favourite group

You can add current channels to the favourite group immediately. Also, you can add a channel to multiple Favourite groups.

1. Press the **OPT+** (  ) button.
2. Select **Favourite** using the **▲/▼** button, and press the **▶** or **OK** (  ) button.
3. Select **favourite group** using the **▲/▼** button and press the **OK** (  ) button to register for Favourite Group.
4. Press the **OK** (  ) button again on the selected **Favourite Group** to release the registered channel.
5. Move to the parent menu using the **◀** button to save the changes automatically.





**Note:** For detailed information about how to change Favourite Group's name and how to register Favourite Channel for the whole channels, refer to **Chapter 7**.



# 4. Basic Operation

## 2. Lock/Unlock a Channel

You can lock or unlock the current channel while watching a programme.



1. Press the **OPT+** (  ) button.
2. Select **Lock** using the **▲/▼** button, and press the **▶** or **OK** (  ) button.
3. Select **Lock** option using the **▲/▼** button, and press the **OK** (  ) button.
4. Select **Unlock** option using the **▲/▼** button, and press the **OK** (  ) button.
5. You will be prompted to enter your Password. Enter your password to unlock the channel.
6. Move to the parent menu using the **◀** button to save the changes automatically.

**Note:** When switching to the Locked Channel, you must enter the password to watch a programme. The Default Password is '0000'.



## 3. Delete a Channel

You can delete the current channel while watching a programme.

1. Press the **OPT+** (  ) button.
2. Select **Delete** using the **▲/▼** button, and press the **OK** (  ) or **▶** button.
3. Select **Yes** in the confirmation message and press the **OK** (  ) button.
4. Enter password using the **NUMERICAL** (0-9) button to delete the current channel and move to the next channel.

**Note:** The Default Password is '0000'.



# 5. Time Shifted Recording

This product automatically saves the programme on air in the installed hard disk drive temporarily, this allows the user to manipulate the saved programme using functions such as rewind, fast forward, replay and pause.

## 5.1 Time Bar

If you press playback control buttons on the remote controller while watching TV, the Time bar appears on the bottom of the screen.

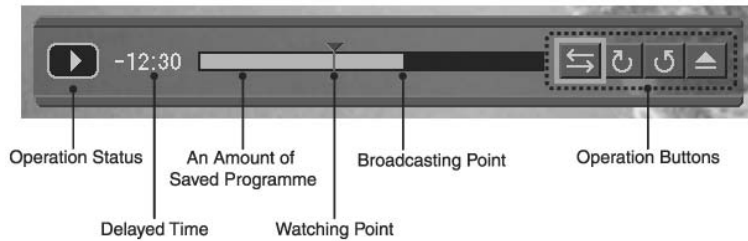

Time bar displays the current operation status, the time difference between the broadcasting point and watching point, and an amount of temporarily saved programme. Time bar also provides 4 operation buttons on the right side for additional time shift operations.

## 5.2 Pause

If you press the **PAUSE** (⏸) button on the remote controller, the current programme is paused. If you press the **PLAY** (▶) or **PAUSE** (⏸) button once again, the programme is resumed from that point.



### Note:

Pause makes the time difference or delay between the broadcasting point and watching point. The time difference is equal to the paused time period. You can check the time difference in the Time bar. Other operations such as slow motion and rewind also make the time difference.

Press the **STOP** (■) button to remove the time difference, and watch the programme on air presently.

## 5. Time Shifted Recording

### 5.3 Fast Rewind to Previous Scene

Press the **FAST REWIND** (⏮) button on the remote controller to watch the scene passed by. Whenever you press the **FAST REWIND** (⏮) button, the rewind speed increases by 3 steps.

If you press the **PLAY** (▶) button, the rewinding operation stops, and the programme will play at normal speed.

**Note:** You can rewind to the point when you have changed to the current channel. If the watching point reaches the start point during rewinding, the programme will begin to play at normal speed from the point.



### 5.4 Fast Forward to the Next Scene

Press the **FAST FORWARD** (⏭) button on the remote controller to fast forward the programme. Whenever you press the **FAST FORWARD** (⏭) button, the speed increases by 3 steps.

If you press the **PLAY** (▶) button, the fast forward operation stops, and the programme will play at normal speed.

**Note:** You can use the fast forward operation only when there is a time difference between the current watching and the broadcasting point caused by some previous operations such as pause, slow motion, and rewind. You can fast forward to the current broadcasting point. If the watching point reaches to the broadcasting point, the programme will play at normal speed.



### 5.5 Slow Motion

Press the **SLOW MOTION** (⏪) button to play the current programme in slow motion.

Press the **SLOW MOTION** (⏪) button once again to play the programme at normal speed.

### 5.6 Recording

Press the **REC** (Ⓜ) button on the remote controller to start recording the current programme. While the time shift operation records the programme temporarily, record operation records the programme permanently so you can playback the recorded programme at any time. For more information about recording, refer to **Chapter 6**.

## 5.7 Additional Time Shift Operations using Time Bar

You can perform additional time shift operations using the 4 operation buttons on the right side of the time bar.

### 1. Direct Jump

Select **DIRECT JUMP** (⏮) and then press the **OK** (⏹) button. A moving arrow appears in progress bar. Move this arrow to a desired time point using the ◀▶ button, and then press the **OK** (⏹) button to play the programme from the specified time point.

### 2. Skip

Select **SKIP** (⏭) and then press the **OK** (⏹) button to play the programme from the time point 30 seconds forward from the current watching point.

You can use the skip operation only when there is a time difference between the current watching and the broadcasting point while you use the fast forward operation. If the time difference is less than 30 seconds, the programme is played from the current broadcasting point.

### 3. Replay

Select **REPLAY** (⏮) and press the **OK** (⏹) button, to replay the current programme from the 7 seconds before. When the replay has been completed, the programme is normally played from the point.

### 4. Displaying a Playlist

Select **PLAYLIST** (📄) and press the **OK** (⏹) button to display the currently saved programme list.

Select desired programme and then press the **OK** (⏹) button to playback the programme.

You can perform the time shift operations like VCR functions using the Playback control buttons while playing a programme.

Press the **STOP** (⏹) button to stop playing the current saved programme, and watch the current programme on air.

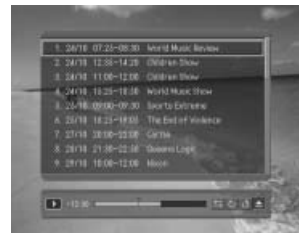

## 6. Recording and Playback

You can record a programme without an external media device such as a VCR.

### 6.1 Instant Recording

Press the **REC** (  ) button on the remote controller to record the current programme instantly.





Press the **STOP** (  ) button to stop recording.

#### Note:

- You cannot change channels during the recording operation. In addition, you cannot move the current screen to the List or Menu screens.
- Ensure that there is enough free space before recording, because if the free space on the hard disk drive is insufficient, recording will stop. Recording 1 hour of programme may require up to 3GB of free space of hard disk space. The space for recording 1 hour of programme may be different depending on the recorded programme.
- You can record Radio programmes as well as TV programmes.



### 6.2 Recording Reservation

You can reserve recording to record your desired programme automatically. You can reserve recording of a programme using **Menu - Record - Recording Schedule** and **Guide**. For detailed information on recording reservation using Guide, refer to **Chapter 8**.

1. Press the **MENU** (  ) button.
2. Select **Record** using the **▲/▼** button and press the **OK** (  ) or **▶** button.
3. Select **Recording Schedule** using the **▲/▼** button and press the **OK** (  ) or **▶** button to display the reserved recording list on the screen.
4. Select a blank list and press the **OK** (  ) button to add a new recording reservation.
5. Select the reserved list and press the **OK** (  ) button to edit the existing reservation information.



## 1. Adding Recording Reservations

1. Enter **Channel Number** using the **NUMERICAL** (0~9) buttons. The channel name changes automatically according to the input channel number
2. Enter **Start Time** using the ◀/▶ button, and **NUMERICAL** (0~9) buttons.
3. Enter **End Time** using the ◀/▶ button, and **NUMERICAL** (0~9) buttons.
4. Select **Repeat** mode from **Once/Daily/Weekly** using the ◀/▶ button.
5. Select **Programme Lock** mode using the ◀/▶ button.
6. When you have finished, select **Save**, and then press the **OK** (  ) button.
7. Select **Cancel**, and then press the **OK** (  ) button to cancel the reservation.

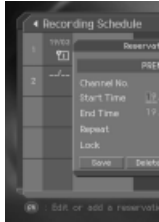



### Note:

- You can reserve 20 programmes for recording.
- If the programme to reserve overlaps with the existing one, adjust the reservation so as not to overlap.
- If the target channel is locked, restricted by watching time or parental control, you have to enter a password for reservation.

## 2. Editing Recording Reservations

Change **Programme Title** using keyboard screen.

1. Enter **Start Time** using the ◀/▶ and **NUMERICAL** (0~9) buttons.
2. Enter **End Time** using the ◀/▶ and **NUMERICAL** (0~9) buttons.
3. Select **Repeat** mode from **Once/Daily/Weekly** using the ◀/▶ button.
4. Change **Programme Lock** mode using the ◀/▶ button.
5. Select **Delete**, and then press the **OK** (  ) button to delete a reservation. This operation is enabled when **Lock** mode is set to Disable.
6. Select **Cancel**, and then press the **OK** (  ) button to cancel an edit operation.
7. Select **Save**, and then press the **OK** (  ) button to finish editing operation.

**Note:** If you have configured **Lock** on a recording reservation, you have to enter a password to playback the recorded programme.

# 6. Recording and Playback

## 6.3 Programme Playback

Select your desired programme from the recorded programme list, and then press the **PLAY** (▶) button to playback the recorded programme.

You can view the programme list recorded by instant recording or reserved recording by selecting **Menu - Record - Recorded Programme**. Otherwise, you can easily view the recorded programme list using **PLAYLIST** (📄) on the right side of the Time bar while you are watching a programme.





1. Press the **MENU** (☰) button.
2. Select **Record** using the ▲/▼ button, and press the **OK** (⏏) or ▶ button.
3. Select **Recorded Programme** using the ▲/▼ button, and press the **OK** (⏏) or ▶ button to display the record programme list.
4. Select the desired programme to playback using the ▲/▼ button, and then press the **PLAY** (▶) button to playback the programme.
5. Press the **STOP** (⏏) button to stop the current programme, and watch the current programme on air.
6. You can perform time shift operations like VCR functions such as rewind, forward, slow motion, pause, skip, and replay using the Playback control buttons on the remote controller or the additional buttons on the right side of the time bar while you are playing back a programme.



**Note:** For more information on the time shift operations like VCR functions, refer to **Chapter 5**.

## 6.4 Editing Recorded Programmes

Select **Menu - Record - Recorded Programme**, and then select the desired recorded programme to edit the information of the programme.

1. Press the **MENU** (  ) button.
2. Select **Record** using the **▲/▼** button, and press the **OK** (  ) or **▶** button.
3. Select **Recorded Programme** using the **▲/▼** button, and press the **OK** (  ) or **▶** button. The recorded programme list appears.
4. Select the desired programme, and then press the **OK** (  ) button to display the edit screen.





**Note:** If you press the **i** (  ) while playing a programme, a screen appears showing the information on the recorded programme.

### 1. Deleting a Recorded Programme

Select **Delete** in the edit screen, and then press the **OK** (  ) button.

### 2. Changing The Name of a Recorded Programme

1. Select **Programme** in the edit screen, and then press the **OK** (  ) button to display a keyboard on the screen.
2. Enter the desired programme name on the keyboard screen using the **▲/▼/◀/▶** and **OK** (  ) button.
3. Select **OK**, and then press the **OK** (  ) button to complete the operation.

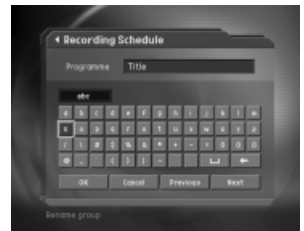



### 3. Protecting Recorded Programmes from Deletion

1. Select **Protect** in the edit screen, and then press the **OK** (  ) or **▶** button to change **Enable** or **Disable**.
2. You have to enter a password to change the status from Enable to Disable.

**Note:** If the protect option of the programme is configured to **Enable**, you cannot delete the programme. Therefore, you have to change the protect option to **Disable** to delete a protected programme.

# 6. Recording and Playback











## 4. Locking a Recorded programme

1. Select **Lock** in the edit screen, and then press the **OK** (  ) or  button to change **Enable** or **Disable**.
2. You have to enter a password to change the status from Enable to Disable.

**Note:** If the Lock option of a programme is configured to **Enable**, you have to enter a password to playback the programme.

## 6.5 Checking Hard Disk Drive

You can check the free space of the hard disk drive, and can format the disk drive if necessary.

1. Press the **MENU** (  ) button.
2. Select **Record** using the  /  button, and press the **OK** (  ) or  button.
3. Select **HDD Control** using the  /  button, and press the **OK** (  ) or  button.
4. You can check the used and free space of the HDD.
5. Select **Format** and press the **OK** (  ) button to remove all the recorded programmes saved on the HDD, and initialise the HDD.
6. Select **Yes** for the format confirm message, and enter a password to start formatting the HDD.



**Note:**

- You have to be careful because performing format deletes all the recorded programmes saved on the HDD.
- Even if you have removed the HDD because it is out of order, you can still watch programmes.



# 7. Channel List

3 types of channel lists are provided for easy and quick channel searching.

- TV** The list of all TV channels with 2 sub-groups: one is sorted by channel number, the other is sorted by channel name.
- Radio** The list of all Radio channels with 2 sub-groups: one is sorted by channel number, the other is sorted by channel name.
- Favourite** The list of the favourite channels with 5 sub-groups that you can organise channels by your private taste.

## 7.1 Displaying and Switching Channel List

You can display channel list using the **LIST** (  ) button and switch into other channel on the channel list.

1. Press the **LIST** (  ) button while watching a programme to display the selected channel list.
2. Select your desired channel using the **▲/▼** button and press the **OK** (  ) button to change the channel.
3. Enter the channel numeric directly using the **NUMERICAL** (0-9) button to move cursor into your desired channel. And then press the **OK** (  ) button to change into the selected channel.
4. Select **On** by going to **MENU - Preferences - Miscellaneous Settings - Option in CH List** to display scramble icon in the channel list.  
Select **OFF** by going to **MENU - Preferences - Miscellaneous Settings - Option in CH List** to display only channel list without scramble icon.

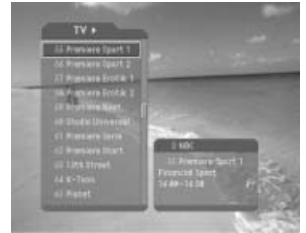



### Note:

- If there are multiple channels, press the **PAGE-/PAGE+** (  ) button to move by page.
- Whenever you press the **TV/RADIO** (  ) button while the channel list is displayed, the channel list will be switched between TV and Radio channel list.

# 7. Channel List



## 7.2 Changing Channel List Group

You can select channel list by group.

1. Press the **▶** button while the channel list is displayed to view the group list.
2. Select your desired channel group using the **▲/▼** button to display its sub-groups.
3. Press the **OK** (  ) or **▶** button, select your desired sub-group using the **▲/▼** button, and then press the **OK** (  ) button.
4. The channel list for the selected sub-group is displayed.





### Note:

- The sub-group of Favourite channel list may exist or not depending on your configuration.
- If **Within the Current Channel List** option is selected from **MENU - Edit channels - Channel Change Mode** menu, you can only change programme within the selected channel list using the **CH-/CH+** (  /  ) while your watching a programme.



## 7.3 Edit Channels

You can edit all channels or each channel by channel list group.

1. Press the **MENU** (  ) button.
2. Select **Edit Channels** using the **▲/▼** button, and press the **OK** (  ) or **▶** button.
3. Select **Edit Channel lists** using the **▲/▼** button, and press the **OK** (  ) or **▶** button.
4. You will be prompted to enter your password. Enter your password using the **NUMERICAL** (0-9) buttons.





### Note:

- Press the **BACK** (  ) or **◀** button to save the changes and return to the previous menu, press the **MENU** (  ) or **EXIT** (  ) button to exit the menu screen.
- You can easily navigate all menus using the assigned numeric for each menu. Press the **MENU - 3 - 1** in order at remote control to select **Edit Channel Lists** menu.



## 1. Select a Channel Group

You can select the channel list group to edit. TV or Radio sub-groups can be selected.

1. Press the **OK** (  ) or **▶** button in group to display **Channel List Group**.
2. Select your desired **Channel List Group** using the **▲/▼** button, and press the **OK** (  ) button.



### Note:

- Press the **TV/RADIO** (  ) button to **move to TV or RADIO channel list** directly.
- For editing **Favourite channel list**, move to **MENU - Edit Channels - Edit Favourite Channels** menu.

# 7. Channel List

## 2. Delete Channels

You can delete one or more channels.

1. Move the cursor to the channel list using the **◀/▶** button.
2. Select your desired channel using the **▲/▼** button, and then press the **OK** (**OK**) button to delete the channel(s). You can select multiple channels.
3. Select **Delete** in the right using the **▶** button, and press the **OK** (**OK**) button.



## 3. Lock/Unlock Channels

You can lock or unlock one or more channels.

1. Move the cursor to the channel list using the **◀/▶** button.
2. Select your desired channel using the **▲/▼** button, and then press the **OK** (**OK**) button to lock/unlock the channel(s). You can select multiple channels.
3. Select **Lock** in the right using the **▶** button, and press the **OK** (**OK**) button.





### Note:

- Only if locked channel(s) is selected or all channels are locked, **Lock** is switched into **Unlock**. When you press **Unlock**, locked channel is switched into unlocked channel.
- Enter password using the **NUMERICAL** (0-9) button to watch locked channel.



## 4. Move Channels

You can move one or more channels into your desired location, which changes the channel number accordingly.



1. Move the cursor to the channel list using the ◀/▶ button.
2. Select your desired channel using the ▲/▼ button, and then press the **OK** (  ) button. You can select multiple channels.
3. Select **Move** in the right using the ▶ button, and press the **OK** (  ) button. Then the selected channel(s) disappears from the channel list for a while.
4. Move the cursor to the desired location in the channel list using the ▲/▼ button, and press the **OK** (  ) button.
5. The selected channel(s) is moved to the selected location in order.



# 7. Channel List

## 5. Rename a Channels



You can change the channel name as you like.

1. Move the cursor to the channel list using the **◀/▶** button.
2. Select your desired channel, and then press the **OK** (  ) button. You can select only single channel.
3. Select **Rename** in the right using the **▶** button, and then press the **OK** (  ) button.
4. Enter a channel name directly using the keyboard displayed on the screen.
5. When finishing entering channel name, select **OK**, and press the **OK** (  ) button.



## 6. Select/Unselect All Channels

You can select/unselect all channels at a time.



1. Select **Select All** in the right and press the **OK** (  ) button to select all channels.
2. Select **Unselect All** in the right and press the **OK** (  ) button to unselect all the selected channels.





# 7. Channel List

## 1. Add/Remove favourite channels

You can add favourite channel(s) to a specific Favourite channel list or remove the added favourite channel(s) from the list.







1. Select **Favourite Group** using .
2. Select your desired channel(s) in all TV/Radio channel list, and press  to add Favourite channel(s).
3. Select your desired channel(s) in Favourite channel list, and press  to remove Favourite channel(s).

**Note:** You can switch between TV and Radio channel list with the **TV/RADIO** () button at remote controller or .



## 2. Move favourite channels





You can move favourite channel(s) to your desired location within the Favourite channel list.

1. Select **Favourite Group** using .
2. Select your desired channel to move within the Favourite channel list and press the **OK** () button.
3. Select , and press the **OK** () button.
4. Move the cursor to your desired location using the  button, and press the **OK** () button.
5. The selected channel(s) is moved to the desired location you selected.



### 3. Rename a favourite channel list

You can rename Favourite channel list.

1. Select Favourite group to rename using .
2. Select , and press the **OK** () button.
3. Enter **Favourite channel list** name using the keyboard displayed on the screen.
4. When finishing entering the Favourite channel list name, select **OK**, and press the **OK** () button.



### 4. Additional Features

Additional Features provide many useful functions which are necessary to add Favourite Channel.

#### Change between TV and Radio channel list

You can add not only TV channel(s) but also Radio channel(s) to Favourite channel list. Press  to switch all channel list into TV or Radio channels.

**Note:** You can also change into TV or Radio channel by pressing the **TV/RADIO** () button on the remote controller.

# 7. Channel List

## Select a favourite channel list

You can select your desired Favourite channel list to edit. Press **Fav** to display the Favourite channel list. Then select your desired channel list using the **▲/▼** button, and press the **OK** (**OK**) button.



## Sort a channel list

You can sort all TV or Radio channel lists by channel number or name for easy Favourite channel editing. If channel lists are sorted by channel number, **abc** is displayed. When you press this button, all the channel lists are sorted by name. Or, if channel lists are sorted by channel name, **123** is switched into **123**. Press this button to order channels by number.

## Unselect all the selected channels

Press **Unselect** button to unselect all the selected channels.

## 7.5 Channel Change Mode

You can change the channel either in the group or in the entire groups while watching a programme.

1. Press the **MENU** (**MENU**) button.
2. Select **Edit Channels** using the **▲/▼** button, and press the **OK** (**OK**) button.
3. Select **Channel Change Mode** using the **▲/▼** button, and press the **OK** (**OK**) or **▶** button.
4. Select **All Channels** or **within the current channel list** using the **▲/▼** button, and press the **OK** (**OK**) button.







**Note:** When **Within the current channel list** is selected, you can only change the channel within the current channel list using the **CH-/CH+** (**CH-/CH+**) buttons. To change the channel in another channel list in which the current channel list is not located, change the channel list group or select **All channels** option.

# 8. Programme Guide

The Programme Guide displays programme information about each channel, based on the date and time. You can also schedule your watching using the information given.

## 8.1 Viewing Programme Guide Information



You can view programme information for all channels.

1. Press the **GUIDE** (  ) button.
2. Move to previous or next programme within the same channel using the **◀/▶** button.
3. Move to other desired channel using the **▲/▼** button. If there are multiple channels, use the **PAGE-/PAGE+** (  ) / (  ) button to move to channels by page. Also, you can enter your desired channel number using the **NUMERICAL** (0-9) button on the remote controller to move to the channel directly.
4. Select your desired programme, and press the **OK** (  ) button. Then you can watch the programme if it is on air, or you can reserve it if it is the following programme.
5. Press the **i** (  ) button in the selected programme to view **detailed information** for the selected programme.



## 1. Viewing Guide Information by Groups

You can view programme information for desired channel list by groups.





1. Press the **GUIDE** (  ) button.
2. Press the **Red** button to display the channel list group.
3. Select your desired channel list group using the **▲/▼** button to display the appropriate sub-group.
4. Move the cursor to the sub-group using the **▶** button, select your desired sub-group using the **▲/▼** button, and then press the **OK** (  ) button.
5. The Programme Guide for selected channel list is displayed.









# 8. Programme Guide



## 2. Viewing Programme Information Using Time Bar

You can quickly search for your desired time zone using the Time bar.

1. Press the **GUIDE** (  ) button.
2. Press the **Green** button to display **Time Bar**.
3. Select the **Time Bar** button using the  /  button, and press the **OK** (  ) button to move as your desired amount of time. If you press the button repeatedly, the same operation is repeated.
4. Each button functions as follows.

- |   |   |
|---|---|
| Now   | Moves to the current programme where the cursor is located. |
|      | Moves to the previous programme or 30 minutes before.       |
|      | Moves to the next programme or 30 minutes after.            |
|      | Moves to 2 hours before.                                    |
|      | Moves to 2 hours after.                                     |
|  Day | Moves to one day before.                                    |
| Day  | Moves to one day after.                                     |







5. Select  button and press the **OK** (  ) button to exit the Time Bar.

**Note:** Guide provides programme information from the previous day to the next 7 days.

## 3. Reserving a Recording

You can automatically reserve your desired programme by selecting the scheduled programme and pressing the **OK** (  ) button.

1. Select the desired programme and press the **OK** (  ) button. The information message will be displayed.
2. Select **OK** and press the **OK** (  ) button to reserve the programme. When a reservation has been completed, the  icon is displayed on the reserved programme.
3. Select **Cancel** and press the **OK** (  ) button not to reserve the programme.
4. If the channel is locked, parental controlled or restricted by watching time, you will be prompted to enter your Password. Enter your Password to complete the reservation.







## 8.2 Finding a Programme

You can find your desired programme by programme name or genre easily.

1. Press the **GUIDE** (  ) button.
2. Press the **Blue** button to display **Find** screen.
3. Enter the programme name directly using the keyboard displayed on the screen.

**Note:** If you select **Previous** or **Next** on the Keyboard displayed on the screen and press the **OK** (  ) button, the keyboard layout is switched.



4. When completing entering programme name, select **Find** button, and press the **OK** (  ) button.
5. If you select your desired programme from **Found Programme List** screen and press the **OK** (  ) button, you can watch the programme if it is on air, or you can reserve your recording if it is the future programme.
6. Select **By Genre** and press the **OK** (  ) button to search programme by genre.
7. Select your desired genre and press the **OK** (  ) button.
8. As the result screen of Find programme by Name, select your desired programme from the Results of Found Programme screen and press the **OK** (  ) button to watch the programme immediately or reserve the programme.

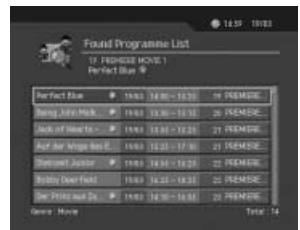

**Note:** **Found Programme List** may differ depending on the provided programme information.



# 8. Programme Guide









## 8.3 Viewing Reserved Programme

You can add or edit reserved programme to be recorded.

1. Press the **GUIDE** (  ) button.
2. Press the **Yellow** button to display **Schedule** screen.
3. Select the scheduled programme and press the **OK** (  ) button to edit the reservation information.
  
4. Select blank list and press the **OK** (  ) button to add a new recording schedule.



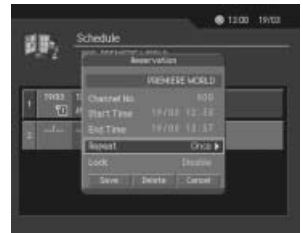

### 1. Edit a Reserved Programme

1. Change the reserved **Start Time** using the  /  button and the **NUMERICAL** (0-9) buttons.
2. Change the reserved **End Time** using the  /  button and the **NUMERICAL** (0-9) buttons.
3. Change the **Repeat** mode using the  /  button. The options are **Once**, **Daily**, and **Weekly**.
4. Select the **Delete** and press the **OK** (  ) button to delete the reserved programme.
5. Select the **Cancel** and press the **OK** (  ) button to cancel the editing.
6. Select the **Save** and press the **OK** (  ) button to complete the editing.



## 2. Add a Reservation

1. Enter your desired **Channel Number** using the **NUMERICAL** (0-9) button. The channel name is automatically displayed by channel number.
2. Enter your desired **Start Time** using the ◀/▶ button and the **NUMERICAL** (0-9) buttons.
3. Enter your desired **End Time** using the ◀/▶ button and the **NUMERICAL** (0-9) buttons.
4. Select one of **Repeat** mode options among **Once**, **Daily**, and **Weekly** using the ◀/▶ button.
5. Select **Lock** mode using the ◀/▶ button.
6. Select **Save** and press the **OK** (  ) button to complete entering.
7. Select **Cancel** and press the **OK** (  ) button to cancel the reservation.





### Note:

- You can reserve up to 20 programmes.
- If your desired programme is overlapped with another programme, adjust the reservation appropriately.
- If the channel is locked or restricted by watching time, you will be prompted to enter the password to complete the reservation.

# 9. Setting Preferences



You can set censorship, watching time, and all other items suitable for your environment.

**Note:**

- Press the **BACK** (  ) or ◀ button to save the changes and return to the previous menu. Press the **MENU** (  ) or **EXIT** (  ) button to exit the Menu screen.
- You can easily select any item from the menu using the **NUMERICAL** (0-9) buttons.

## 9.1 Parental Control



You can set parental control for each programme and watching time. You can also change your Password.

1. Press the **MENU** (  ) button.
2. Select **Preferences** using the ▲/▼ button, and press the **OK** (  ) or ► button.
3. Select **Parental Control** using the ▲/▼ button, and press the **OK** (  ) or ► button.
4. When a prompting message is displayed to request your password, enter the password using the **NUMERICAL** (0-9) button.



### 1. Set Censorship

**Censorship Classification** allows you to block programmes according to the age level you have set.

1. Select **Censorship Classification** using the ▲/▼ button, and press the **OK** (  ) or ► button.
2. Select your desired **age level** using the ▲/▼ button, and press the **OK** (  ) button.



- View All** All programmes can be watched because there is no age limitation.
- 7** Programmes are blocked for children under the age of 7.
- 12** Programmes are blocked for children under the age of 12.
- 15** Programmes are blocked for children under the age of 15.
- 18** Programmes are blocked for children under the age of 18.
- Lock All** Programmes are blocked without considering the age level.

**Note:** You have to enter Password to watch the programme which is blocked by the age level.



## 2. Set Allow Watch Time

You can block programmes according to the watching time for all the channels.

1. Select **Allow Time Control** using the ▲/▼ button.
2. Select Enable or Disable **Allow Time Control** using the ► or **OK** (  ) button.

**Disable** You can watch a programme whenever you want regardless of Allow Time.

**Enable** You can watch a programme only while the time specified by Allow Time.

3. When you have selected **Enable**, set the Start and End Time using the **NUMERICAL** (0-9) buttons, and press the **OK** (  ) button.
4. If you wish to cancel the entered time, select **Cancel** button, and press the **OK** (  ) button.



**Note:** Once the setting has been completed, you can watch programme only during the time specified by Allow Time. Otherwise you will need to enter the Password to watch any programme during unspecified time.



# 9. Setting Preferences

## 3. Change Password

You can change the existing password into new one.



1. Select **Change Password** using the ▲/▼ button, and press the ► or **OK** (  ) button.
2. Enter **New Password** using the **NUMERICAL** (0-9) button, and select **OK** and press **OK** (  ) button.
3. Enter **New Password** again to confirm **Verify Password**, and press the **OK** (  ) button.

**Note:** The Default Password is "0000". If you have forgotten your Password, please contact your local product distributor.



## 9.2 Language Setting



You can set Language for Menu, Audio, and Subtitle.

1. Press the **MENU** (  ) button.
2. Select **Preferences** using the ▲/▼ button, and press the **OK** (  ) or ► button.
3. Select **Language Setting** using the ▲/▼ button, and press the **OK** (  ) or ► button.



## 1. Menu Audio/Subtitle Language

You can set the language for Menu, Audio and Subtitle.

1. Select **Menu/Audio/Subtitle Language** using the ▲/▼ button.
2. Press the ► or **OK** (  ) button to display the available **Language List**.
3. Select your desired language using the ▲/▼ button, and press the **OK** (  ) button.

## 2. Audio Priority

You can select the priority of audio.

1. Select **Audio Priority** using the ▲/▼ button.
2. Select one option from **Language** or **Dolby Digital** using the ► or OK (  ) button.

**Language**

You can watch programme in the selected language.

**Dolby Digital**

You can listen sound in Dolby Digital mode.

## 3. Subtitle Display

You can select whether or not to display the Subtitle automatically if provided.

1. Select **Subtitle Display** using the ▲/▼ button.
2. Select one option from **Auto** or **Manual** using the ► or OK (  ) button.

**Auto**

Subtitles are displayed automatically in the predefined subtitle language.

**Manual**

Subtitles are displayed in the language when you select the subtitle language by pressing the **SUBTITLE** (  ) button on the remote controller.

## 4. Subtitle Font

You can select the Subtitle font.

1. Select **Subtitle Font** using the ▲/▼ button.
2. Select one option from **Variable** or **Fixed** using the ► or OK (  ) button.

**Variable**

Uses the horizontally variable Subtitle Font.



**Fixed**

Uses the fixed Subtitle Font.

# 9. Setting Preferences

## 9.3 Time Setting



You can specify the current time and Power On/Off time.

1. Press the **MENU** (  ) button.
2. Select **Preferences** using the **▲/▼** button, and press the **OK** (  ) or **▶** button.
3. Select **Time Setting** using the **▲/▼** button, and press the **OK** (  ) or **▶** button.



### 1.Set Current Time

You can set the GMT Offset for current time.

1. Select **GMT Offset** using the **▲/▼** button.
2. Press the **▶** or **OK** (  ) button to display **GMT list**. GMT is changed by from 30 minutes to 1 hour.
3. Select your GMT offset using the **▲/▼** buttons, and press the **OK** (  ) button.



**Note:** The current time is set automatically whenever GMT Offset changes.

The default item is **Auto**.

If GMT offset is Auto, it is automatically set depending on your country. However, if the time is NOT set properly, you can change GMT Offset to fit your local time.

## 2. Power On

You can set the time when the product is automatically powered on.

1. Select **Power On** using the ▲/▼ button.
2. Select either **Enable** or **Disable** the Power On using the ► or OK (  ) button.

**Enable** Uses the Power On and sets the Power On time.

**Disable** Not uses the Power On.

3. When you have selected **Enable**, enter **Channel No** and **Time** using the **NUMERICAL** (0-9) buttons, and press the OK (  ) button.



## 3. Power Off

You can set the time when the product is automatically powered off.

1. Select **Power Off** using the ▲/▼ button.
2. Select either Enable or Disable **Power Off** using the ► or OK (  ) button.

**Enable** Uses the Power Off and sets the Power Off time.



**Disable** Not uses the Power Off.

3. When you have selected **Enable**, enter the **Time** using the **NUMERICAL** (0-9) button, and press the OK (  ) button.

**Note:** Once Power On/Off is specified, it is repeated everyday.

## 9.4 A/V Control

You can set Audio or Video Output Control.



1. Press the **MENU** (  ) button.
2. Select **Preferences** using the ▲/▼ button, and press the OK (  ) or ► button.
3. Select **AV Control** using the ▲/▼ button, and press the OK (  ) or ► button.



# 9. Setting Preferences

## 1. TV-SCART

You can set TV SCART Output.

1. Select **TV-SCART** using the ▲/▼ button, and press the **OK** (  ) or ► button.
2. Select one option among **CVBS/RGB/S-Video** using the ▲/▼ button, and press the **OK** (  ) or ► button.

## 2. VCR-SCART

You can set VCR-SCART Output.

1. Select **VCR-SCART** using the ▲/▼ button, and press the **OK** (  ) or ► button.
2. Select one option from **CVBS/S-Video** using the **OK** (  ) or ► button.

## 3. Audio Output

You can set the Audio Output.

1. Select **Audio Output** using the ▲/▼ button.
2. Select one option from **Stereo or Mono** using the ► or **OK** (  ) button.



## 4. Screen Ratio

You can set the aspect ratio of your TV.

1. Select **Screen Ratio** using the ▲/▼ button.
2. Select one option from **4:3 or 16:9** using the ► or **OK** (  ) button.



## 5. Display Format

You can select the Display Format according to TV Screen Ratio.

1. Select **Display Format** using the ▲/▼ button, and press the **OK** (  ) or ► button.
2. If the Screen Ratio is set to **'4:3'**, you can select one among **Auto/Letter box/Center Mode** using the ▲/▼ button, and press the **OK** (  ) button.
3. If the Screen Ratio is set to **'16:9'**, you can select one among **Auto/Pillar box/Full mode** using the ▲/▼ button, and press the **OK** (  ) button.

## 9.5 UHF Tuning



You can set the UHF channel.

1. Press the **MENU** (  ) button.
2. Select **Preferences** using the  $\blacktriangle/\blacktriangledown$  button, and press the **OK** (  ) or  $\blacktriangleright$  button.
3. Select **UHF Tuning** using the  $\blacktriangle/\blacktriangledown$  button, and press the **OK** (  ) or  $\blacktriangleright$  button.



### 1. UHF Channel



You can select UHF Channels for the TV. The Channel range and Frequency change according to PAL Standard.

1. Select **UHF Channel** using the  $\blacktriangle/\blacktriangledown$  button, and press the **OK** (  ) or  $\blacktriangleright$  button.
2. Select channel range based on the following channel criteria using the  $\blacktriangle/\blacktriangledown$  button, and press the **OK** (  ) button.

<b>CH21-CH69</b>	PAL I/G for Europe
<b>CH28-CH69</b>	PAL B for Europe/Australia



### 2. PAL

You can select the PAL standard.

1. Select **PAL** using the  $\blacktriangle/\blacktriangledown$  button, and press the **OK** (  ) or  $\blacktriangleright$  button.
2. Select one option among **PAL I/PAL G/PAL B** using the  $\blacktriangle/\blacktriangledown$  button, and press the **OK** (  ) button.



### 3. UHF Offset

You can adjust fine tuning setting.

1. Select **UHF Offset** using the  $\blacktriangle/\blacktriangledown$  button, and press the **OK** (  ) or  $\blacktriangleright$  button.
2. Select a range between **-4~+4** using the  $\blacktriangle/\blacktriangledown$  button, and press the **OK** (  ) button.

# 9. Setting Preferences

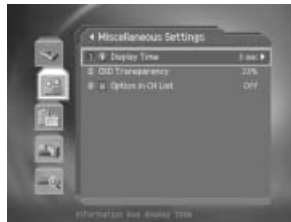

## 9.6 Miscellaneous Settings

1. Press the **MENU** (  ) button.
2. Select **Preferences** using the  $\blacktriangle/\blacktriangledown$  button, and press the **OK** (  ) or  $\blacktriangleright$  button.
3. Select **Miscellaneous Settings** using the  $\blacktriangle/\blacktriangledown$  button, and press the **OK** (  ) or  $\blacktriangleright$  button.



### 1. i-Plate Display Time

You can set the duration during which the Information box is to be displayed when you switch the channel.

1. Select **i-Plate Display Time** using the  $\blacktriangle/\blacktriangledown$  button, and press the **OK** (  ) or  $\blacktriangleright$  button.
2. Select a value between 1~20 seconds using the  $\blacktriangle/\blacktriangledown$  button, and press the **OK** (  ) button.

**Note:** When it is set to **Disable**, the i-Plate will not be displayed when you switch the channel.

### 2. OSD Transparency

You can set the transparency of On Screen Display (OSD).

1. Select **OSD Transparency** using the  $\blacktriangle/\blacktriangledown$  button, and press the **OK** (  ) or  $\blacktriangleright$  button.
2. Select one option among **Disable/25/50/75** using the  $\blacktriangle/\blacktriangledown$  button, and press the **OK** (  ) button.

<b>Disable</b>	Fully opaque screen
<b>25, 50, 75</b>	As the number is bigger, the screen is more transparent.

### 3. Option in CH List

You can set whether or not to display the scrambled icon in channel list.

1. Select **Option in CH List** using the  $\blacktriangle/\blacktriangledown$  button.
2. Select one option from **On/Off** using the  $\blacktriangleright$  or **OK** (  ) button.



<b>On</b>	Scramble icon displays in the channel list.
<b>Off</b>	Scramble icon disappears in the channel list.

# 10. Installation

This chapter describes how to search for channels and a series of procedures.

## 10.1 Automatic Search





If your receiver is connected to the aerial and television, you can automatically search channels without entering any other information.

1. Select **MENU** (  ) button.
2. Select **Installation** using the **▲/▼** button, and press the **OK** (  ) or **▶** button.
3. Enter Password using the **NUMERICAL** (0~9) buttons.
4. Select **Automatic Search** from Installation menu using the **▲/▼** button, and press the **OK** (  ) or **▶** button.
5. Receiver starts to search channels automatically.



## Search

Wait while the receiver searches for the channels, this may take a few minutes.

1. During operating search, the cursor is located at **Stop**. Therefore, if you press the **OK** (  ) button during searching, the operation is stopped and the channels found until then will be displayed.
2. If search operation is successfully completed, and the channel does not exist, press the **OK** (  ) button and try to reset the search operation again if necessary.
3. You can delete unnecessary channels from the searched channels. Select your desired channels to delete and press the **OK** (  ) button. Then select **Delete** and press the **OK** (  ) button. To delete all channels, select **Select All** to select all channels, select **Delete**, and press the **OK** (  ) button.
4. When completing Channel Search and deleting unnecessary channels, select **Save** to save the changes.





# 10. Installation

## 10.2 Manual Search

You can search channels manually by searching parameters, if you know the MUX information.

### 1. Channel Number



Enter your desired frequency channel to search. When entering frequency channel value, the appropriate frequency value is entered.

1. Select **Channel** using the ▲/▼ button, and press the **OK** (  ) or ► button.
2. Select one of channel using the ▲/▼ button, and press the **OK** (  ) button.



### 2. Frequency



Enter your desired frequency to search directly. When entering frequency, the appropriate channel for the entered frequency is automatically displayed on Channel.

1. Select **Frequency** using the ▲/▼ button, and press the **OK** (  ) or ► button.
2. Enter frequency using the **NUMERICAL** (0-9) button and press the **OK** (  ) button.



### 3. Network Search

If specified frequency channel information and other channel information are provided together, the channel, which belongs to other frequency channel, is also searched.

1. Select **Network Search** using the ▲/▼ button, and press the **OK** (  ) or ► button.
2. Select one option between **Enable** and **Disable** using the ► or **OK** (  ) button.









## 10.3 Default Setting

Default Setting restores the receiver to the default settings.

**Warning:** Please note that once you perform Default Setting, all data such as Channel List, and User Configured data are deleted.

To perform Factory Default:



1. Press the **MENU** (  ) button.
2. Select **Installation** using the **▲/▼** button, and press the **OK** (  ) or **▶** button.
3. Enter **Password** using the **NUMERICAL** (0-9) button.
4. Select **Default Setting** using the **▲/▼** button, and press the **OK** (  ) or **▶** button.
5. Select **Yes** and press the **OK** (  ) button to restore all setting to Factory Default.  
Select **No** and press the **OK** (  ) or **BACK** (  ) button to return to the previous menu.
6. Confirm again to start loading default setting. Enter **Password** using the **NUMERICAL** (0-9) button to perform restoring.
7. When completing the default setting, press the **OK** (  ) button to automatically run **Installation Wizard**.  
When default setting is completed, Installation Wizard is automatically displayed, which helps Channel Search. For detailed information about Installation Wizard, refer to **3. Installation Wizard**.



# 10. Installation

## 10.4 Antenna Power

This is used when you connect an active antenna to the **ANTENNA IN** connector on the rear of the receiver.

1. Press the **MENU** (  ) button.
2. Select **Installation** using the **▲/▼** button, and press the **▶** or **OK** (  ) button.
3. Select **Antenna Power** from Installation menu using the **▲/▼** button.
4. Press the **▶** or **OK** (  ) button to select **On or OFF**.

**On** 5V power supply from the active antenna cable.

**Off** No power supply.

**Note:** The default value is “Off”.



# 11. Software Update

In order to maintain proper performance of this product, it is essential to have the most up to date software. The latest news and release of software versions may be found at Humax website - <http://www.humaxdigital.com>.

It is recommended that you periodically check for the availability of software upgrade.

## 11.1 OTA (Over the Air)

OTA, an abbreviation of "over the air", means that downloads the software where the manufacturer reserves the right to decide when and where to release through aerial.

Over the Air (OTA) is simply another alternative for downloading software versions. However, the manufacturer reserves the right to decide when and where this software update can take place by "beaming" latest software versions over the air via aerial. The software update via aerial will only occur under the following circumstances.

1. The equipment should have appropriate loader software.  
**Caution:** Please note that if you don't have normal loader software, the equipment may not be updated or work after software update.
2. The manufacturer decides to release software downloading via a designated aerial
3. The equipment must be "tuned" properly to the same aerial that the manufacturer uses.
4. Update software when the quality of receiving signal strength is high. If the weather is not so good that the quality of receiving signal strength is not recommendable, perform the software upgrade later.

### Caution:

- Please be careful to keep the power on and the power cord plugged in during software update. If the power is off during software update, it may cause fatal damage to the product.
- Please be careful not to pull out the Signal line (Aerial Cable) during software update. Update may be interrupted and the product may not work.

### Note:



- The product cannot work at all during software update.
- It may take 5 ~10 minutes to update software.
- Scheduling operation cannot work during software update.

### 1. If new software is found when powering on

1. A message will be displayed to notify that new software is found.
2. Select **Yes** and press the **OK** (  ) button to update the software.
3. Starts downloading new software. Please wait until the updated is completed.
4. When completing the software update, the equipment is automatically powered off and on again.

# 11. Software Update

## 2. If updating software from Menu

1. Press the **MENU** (  ) button.
2. Select **Installation** using the **▲/▼** button, and press the **OK** (  ) or **▶** button.
3. Enter **Password** using the **NUMERICAL** (0-9) buttons.
4. Select **Software Update** using the **▲/▼** button, and press the **OK** (  ) or **▶** button.







## 3. If new version of software is detected during watching a programme

Press the **OK** (  ) button to start updating.



## 4. If using Automatic Update

You can set the product to find HUMAX software update site and update software automatically.

1. Select **Automatic Update** from **Software Update Menu** screen using the **▲/▼** button, and press the **OK** (  ) or **▶** button.
2. Automatically search for new software. Select **Cancel** and press the **OK** (  ) button to cancel Search.
3. When detecting update software, the following result is displayed. If new software is not found by Automatic, use **Manual Update**.
4. Select **Yes** and press the **OK** (  ) button to start updating.  
Select **No** and press the **OK** (  ) button to return to the previous menu without updating.







## 5. Manual Update

You can perform Manual Update only if you know MUX information of software update correctly.

1. Select **Manual Update** from **Software Update** screen using the ▲/▼ button, and press the **OK** (  ) or ► button.
2. Select **Channel Number** which provides update software. You can also enter **Frequency** instead of channel number in which updated software is provided.
3. Select **Mode**. If the information is not known, then **Auto** can be selected.
4. Select **Guard Interval**. If the information is not known, then **Auto** can be selected.

**Note:** How to setting parameters in **Manual Update** is the same as how to set parameters in **Manual Search**. Refer to **Manual Search**.

5. Select **Search** and press the **OK** (  ) button to search software.
6. It is displayed whether or not New Software exist. If new software does not exist, press the **OK** (  ) button to return to the Manual Update Menu.
7. Select **Yes** and press the **OK** (  ) button to start updating. Select **NO** and press the **OK** (  ) button to return to the previous menu.
8. Performs Software Update. Please wait until it is completed.
9. When completing the software update, the product is automatically powered off and on again.







# 11. Software Update

## 6. Regular Auto Update and Search Time

You can specify the Regular Auto Update and Search Time.

Your receiver starts the Regular Auto Update in the standby mode.

1. Select **Regular Auto Update** using the ▲/▼ button, and press the **OK** (  ) or ► button.
2. Select **Enable** or **Disable** and press the **OK** (  ) or ► button whether or not setting the Search time automatically.
3. When you select **Enable**, set the **Search Time** using the **NUMERICAL** (0–9) buttons, and select **OK**, and press the **OK** (  ) button.
4. If you wish to cancel the entered time, select **Cancel**, and press the **OK** (  ) button.



## 11.2 S/W Update from PC

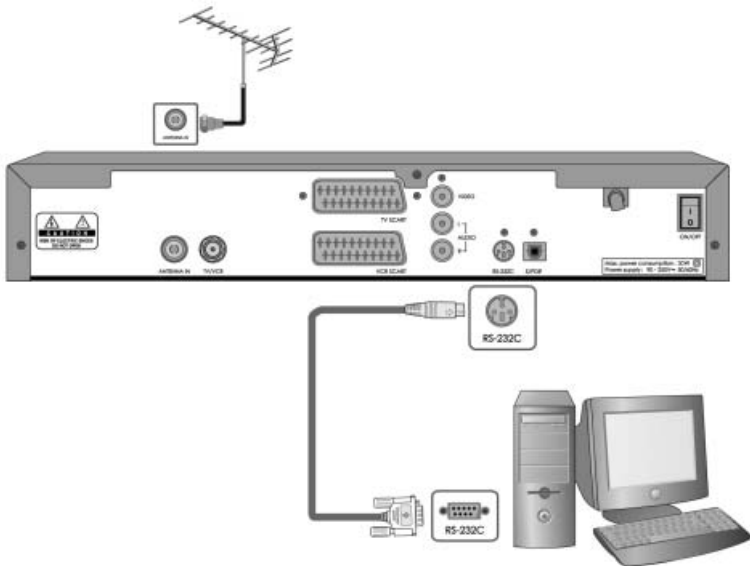

You can connect your receiver to the PC directly and upgrade your software by transferring the new software from the PC. Follow these steps to download new software from PC to this product.

1. Download new software file (HDF files) equivalent for this product model from our website into your computer (<http://www.humaxdigital.com>).
2. Download and install download tool file from our website into your computer.
3. Connect your PC to this product with RS-232C serial cable.
4. Execute installed download tool, and then follow the instructions contained the download tool.
5. Press the **Power ON/OFF** button to make this product operating.



# 12. System Information

You can view all system information, signal strength and quality.

1. Press the **MENU** (  ) button.
2. Select **System** using the **▲/▼** button, and press the **OK** (  ) or **▶** button.



## 12.1 Status

You can view System information.

1. Select **Status** using the **▲/▼** button, and press the **OK** (  ) or **▶** button.
2. Confirm the information about **Hardware version**, **Softwareversion**, **Loader version**, **System ID**, and **Update Date**.



## 12.2 Signal Detection



You can view the signal strength and signal quality receiving for the channel that is currently on AV.

1. Select **Signal Detection** using the **▲/▼** button, and press the **OK** (  ) or **▶** button.
2. Display the channel name, frequency, mode, and guard interval of terrestrial frequency. In addition, it displays currently tuned channel number and its name, and the graphs and percentage of Signal Strength and Quality of the channel.



## 13. Games

This product provides various games for user's entertainment.

1. Press the **GAME** () button.
2. According to the instruction displayed on screen, you can enjoy the game using the  and **OK** () button.



**Note:** Press the **EXIT** () or **BACK** () button to exit the game.

# 14. Manipulating your TV using Remote Control

You can manipulate TV using the remote control provided by Humax.

**Note:** This function may not be supported depending on TV model.

## TV code setting

1. Point the remote control towards the remote control receiving parts of TV.
2. Press and hold the **TV** (  ) button. After 3 seconds the TV button LED will illuminate (under your finger). With the **TV** (  ) button still pressed and illuminated, enter the three numbers of the TV code using the **NUMERICAL** (0~9) button orderly. (Refer to the following Code for TV manufacturer.)
3. When the correct code is entered, the TV power turns on / off.
4. If TV fails to turn off, repeat the process using the alternate TV codes.

**[Code for TV manufacturer] Table**

Brand	Code	Brand	Code
A MARK	002	ARCAM	062,063
ABEX	016	ARCHER	002
ACTION	110,124	ASUKA	064,071
ACURA	004	ATLANTIC	098
ADMIRAL	030,042,076,099,123	AUDINAC	081
ADYSON	016,063	AUDIOSONIC	018,071
AIKO	029	AUDIOVOX	002,029,052,084
AKAI	015,099,109,124	AUMARK	026
AKURA	064,071	AUTOVOX	068,076,097
ALARON	051,055,062	BARCO	086
ALBA	004,017,018,064,123	BASIC LINE	004,064
ALLORGAN	118	BAUR	018,087,097,099,102, 108
AMBASSADOR	049	BAYSONIC	052
AMPLIVISION	063	BEAUMARK	050
AMSTRAD	004,018,047,049,145	BEC	099,110,124
ANAM	003,004,052	BECRESE	040,099,108,109,110
ANAM NATIONAL	024	BELCOR	009
ANITECH	004,071	BELL & HOWELL	006,038,106
ANITECH	071	BEON	018
ANSONIC	127	BINATONE	063
AOC	002,009,015,056		

Brand	Code	Brand	Code
BLACKSTRIPE	040	CITIZEN	040,057,074
BLACKSTRIPE	106	CLAIRTONE	056
BLACKSTRIPE	108	CLARIVOX	018
BLAUPUNKT	059,060,061	CLARIVOX	125
BLUE SKY	064	CLATRONIC	098
BLUE STAR	075	CLATRONIC	127
BOOTS	063	CME	004,005,017,018,028, 042,049,063,065,066, 068,076,079,087
BOSCH-BAUER	098	CONCERTO	025
BPL	075	CONDOR	098
BRADFORD	052	CONIC	110
BRINKMANN	123	CONTEC	004,017,052,056,062
BRITANNIA	062	CONTINETAL	141
BROCKWOOD	009	CRAIG	105
BROKSONIC	002,067,085	CRIPTOVISION	023
ROTHER	071	CROSLEY	110
BRUNS	126	CROSLEY	004,018,019,052,127
BSR	093,118	CROWN	098
BTC	064	CTC	006,015,019,020,021, 023
BUSH	004,017,018,064,075, 093,099,117	CURTIS MATHES	026,030,035,038,025, 040,044,084,106
CANDLE	015,025,057	CXC	052
CAPEHART	124	CYBERTON	064
CAPSONIC	071	DAEWOO	004,009,018,019,029, 084,133
CARNIVALE	015	DAINICHI	064
CARREFOUR	017	DANSAI	018
CARVER	023,046	DAYTON	004,009,019,018
CASCADE	004	DE GRAAF	006
CATHAY	018	DECCA	018,028,129
CCE	063,018,078	DENON	035
CCI	115	DESMET	098
CENTURION	018	DIXI	003,004,018,126
CGE	101,123	DUAL	097
CIE	133		
CIMLINE	004,117		
CINERAL	029,084		
CITIZEN	015,019,025,026,029,		

## 14. Manipulating your TV using Remote Control

Brand	Code	Brand	Code
DUAL TEC	063	FUNAI	047,051,052,071,118
DUMINT	127	FUTURETECH	052
DUMONT	007,009	GALAXIS	123,142
DYNATECH	063	GBC	099
EB TELECOM	105	GE	011,013,020,021,024, 030,034,050,075,084
EC	018,028,063,095,110, 129	GELOSO	004,099
ECTEC	081	GENEXXA	042,064
EDISON	052	GIBRALTER	007,009,015
ELECTROBAND	056	GO VIDEO	026
ELECTROHOME	080,106,110	GOLDSTAR	000,001,009,015,016, 018,019,025,033,050, 063,071,093,110,124, 140
ELECTRONIC	071,133,146,018,028,	GOODMANS	017,018,028,051,063, 133
ELEKTA	071	GPM	064
ELIN	018	GRADIENTE	022,025,046,082
ELITE	040,064,098,106	GRADIN	098
ELMAN	127	GRAETZ	042,099
ELTA	004	GRANADA	018,028,063,109,124
EMERSON	009,019,038,049,050, 051,051,053,054,055, 056,067,072,074,075, 085	GRANDIN	075
ENVISION	015	GRUNDIG	018,059,060,068,137
ERRES	018	GRUNPY	051
EURO-FEEL	071	GRUNPY	052
EUROMANN	071	HALIEAX	071
EUROPHON	127	HALLMARK	050
FERGUSON	018	HANSEATIC	018,089,097,098,099, 118,119
FIDELITY	062,097,104	HARLY DAVIDSON	051
FINLADIA	106	HARMAN KARDON	023
FINLUX	018,028,051,093,129	HARVARD	052
FIRST LINE	118,004,062,063	HCM	004,071,075
FISHER	038,041,063,097,106, 108,126	HEMMERMANN	097
FORMENTI	018,098,103	HINARI	004,017,018,051,064
FRONTECH	042,071,099	HITACHI	094,095,096,099,102,
FUJITSU	028,051,124		

Brand	Code	Brand	Code
HITACHI	108,109,110,111,112, 113,114,124,148,016, 017,025,031,032,035, 037,042,048,063,066, 090,091	KEC	052
HUANYU	062	KENDO	018,099,117,119,127
HUSPI ELEKTRONIK	123	KENWOOD	009,015
HYPERVISION	134	KINGSLEY	062
HYPSON	018,071,075	KLH	124
HYPSON	071,075	KLOSS	012
ICE	063,071	KMC	033
ICES	064	KONIG	004,005,017,018,042, 061,068
IMPERIAL	092,099,101,123	KORPEL	018
INDESIT	068	KORTING	098
INDIANA	018	KOYODA	004
INFINITY	023	KTV	015,019,052,055,056, 063,074
INGEKEN	139	KUBA	097
INGELEN	042	LENCO	071,118,124
INNOHIT	028,124	LG	025
INNOVA	018	LIESENK & TTER	018
INTEQ	007	LIFETEC	071
INTERBUY	071	LLOYTRON	016
INTERFUNK	018,042,095,099	LOGIK	000,006
INTERVISION	018,063,071,127,144	LUMA	099
ISUKAI	064	LUXMAN	025
ITT	042,099,108	LUXOR	068,094,099,102,124
JACSON	129	LXI	007,020,023,038,040, 050,106
JBL	023	M ELECTRONIC	004,018,042,063,097, 127
JCB	137	MAGNAFON	127
JEC	040	MAGNASONIC	106
JVC	017,022,045,054	MAGNAVOX	010,012,014,015,017, 023,051,057,058,110
KAISUI	004,062,063,064,075	MAJESTIC	006
KAMP	062	MANDOR	071
KAPSCH	042,095,099	MANESTH	063,071,098,117
KATHREIN	089	MARANTZ	015,018,023,089
KAWASHO	062,077		

## 14. Manipulating your TV using Remote Control

Brand	Code	Brand	Code
MARK	018	NIKKAI	016,018,028,040,062, 064,071,124
MATSUI	004,005,018,049,063, 092,097,117	NIKKO	007,015,020,029,038, 040,050
MATSUSHITA	021,070	NISATO	081
MC MICHAEL	110	NOBLEX	083
MEDIATOR	018	NOKIA	071,094,095,096,099, 106,108,143
MEGATRON	002,035,050,109	NOSHI	008
MEI	056	NTC	029
MEMOREX	004,006,025,026,033, 036,038,050,070,071, 106	OCEANIC	042,099,106,118
MEMPHIS	124	ONWA	052
MGA	009,015,036,039,050	OPTIMUS	038,044,070
MIDLAND	007,016,019,020,021, 034	OPTIONICA	030,043
MINERVA	068	ORION	018,049,051,067,085, 097,098,118
MINUTZ	011	OSAKI	016
mitsubishi	009,017,030,036,039, 050,068	OSAKI	028
MIVAR	062	OSAKI	063
MOTOROLA	024,030	OSAKI	064
MTC	009,015,025,026,056, 062	OSAKI	071
MULTISTANDARD	127	OSAKI	124
MULTITECH	004,052,062,063,099, 127	OSO	064
MUTIMEDIA	132	OSUME	016,028,124
NAD	040,044,050	OTTO VERSAND	017,018,059,063,087, 089,093,097,098,099, 102,108,117,118
NAONIS	099	PALLADIUM	099
NATIONAL	068	PANAMA	063,071
NEC	009,015,017,025,046	PANASONIC	000,020,021,022,023, 024,026,030,035,036, 038,040,042,043,050, 065,068,070,079,099
NECKERMANN	018,059,087,089,099, 102	PATHE CINEMA	062,098
NEI	018	PAUSA	004
NESCO	051	PCE/PEC	040,106,108
NETSAT	018		

Brand	Code	Brand	Code
PENNEY	001,102,008,009,011, 013,015,016,019,020, 021,025,026,034,040, 050	RADIOTONE	071
PHASE	016	RADIX	108
PHILCO	009,010,012,014,015, 023,035,057,058,085, 123	RANK ARENA	017
PHILIPS	007,008,009,010,011, 012,013,018,019,023, 089,110,124,138	RCA	008,009,020,021,030, 034
PHONOLA	018,098	REALISTIC	009,015,016,019,025, 038,043,050,052,106
PILOT	009,015,019	REKORD	149
PIONEER	042,044	REVOX	018
POLICOM	068	REX	042,071,076,099
POLYRON	071	RFT	088,126
PORTLAND	009,019,029	RHAPSODY	055,056,062
PRANONI PRINCE	099	R-LINE	018
PRIMA	040,106	ROADSTAR	004,064,071
PRINZ	124	ROYAL LUX	131
PRISM	021	RTF	018
PROFEX	004	RUNCO	007,015
PROLINE	119	SABA	042,095,099
PROSCAN	015,020	SAGEM	139
PROTEC	099,127	SAISHO	004,005,049,071,117
PROTECH	004,018,063,071	SAKIO	071
PROTON	002,050	SALORA	042,094,099,102,106, 124
PULSAR	007,009,110,124	SAMBERS	127
QUASAR	021,024,043,070	SAMPO	015,016,019
QUELLE	005,018,087,093,097, 099,108,117,118	SAMSUNG	004,009,015,016,018, 019,025,026,050,063, 071,078,089,124,137
QUESTA	017	SAMSUX	019
RADIO SHACK	009,015,016,019,020, 025,038,043,050,052, 106	SANDRA	062
RADIOLA	018	SANSEI	084
		SANSUI	085
		SANYO	005,017,028,038,041, 106,107,108,124,129
		SBR	018
		SCHAUB LORENZ	099

## 14. Manipulating your TV using Remote Control

Brand	Code	Brand	Code
PENNEY	001,102,008,009,011, 013,015,016,019,020, 021,025,026,034,040, 050	RADIOTONE	071
PHASE	016	RADIX	108
PHILCO	009,010,012,014,015, 023,035,057,058,085, 123	RANK ARENA	017
PHILIPS	007,008,009,010,011, 012,013,018,019,023, 089,110,124,138	RCA	008,009,020,021,030, 034
PHONOLA	018,098	REALISTIC	009,015,016,019,025, 038,043,050,052,106
PILOT	009,015,019	REKORD	149
PIONEER	042,044	REVOX	018
POLICOM	068	REX	042,071,076,099
POLYRON	071	RFT	088,126
PORTLAND	009,019,029	RHAPSODY	055,056,062
PRANONI PRINCE	099	R-LINE	018
PRIMA	040,106	ROADSTAR	004,064,071
PRINZ	124	ROYAL LUX	131
PRISM	021	RTF	018
PROFEX	004	RUNCO	007,015
PROLINE	119	SABA	042,095,099
PROSCAN	015,020	SAGEM	139
PROTEC	099,127	SAISHO	004,005,049,071,117
PROTECH	004,018,063,071	SAKIO	071
PROTON	002,050	SALORA	042,094,099,102,106, 124
PULSAR	007,009,110,124	SAMBERS	127
QUASAR	021,024,043,070	SAMPO	015,016,019
QUELLE	005,018,087,093,097, 099,108,117,118	SAMSUNG	004,009,015,016,018, 019,025,026,050,063, 071,078,089,124,137
QUESTA	017	SAMSUX	019
RADIO SHACK	009,015,016,019,020, 025,038,043,050,052, 106	SANDRA	062
RADIOLA	018	SANSEI	084
		SANSUI	085
		SANYO	005,017,028,038,041, 106,107,108,124,129
		SBR	018
		SCHAUB LORENZ	099

Brand	Code
SCHNEIDER	018,064,071,097,136, 143,147
SCIMITSU	009
SCOTCH	050
SCOTT	009,050,051,052,067
SEARS	020,023,025,038,040, 041,047,050,051,106
SEG	017,063,071,126,127
SEI	049
SEI-SINUDYNE	097,099,117,118,127
SELECO	042,076,099,100,119, 120,122
SEMIVOX	052
SEMP	040
SENTRA	040
SHARP	017,019,030,043
SHOGUN	009
SHORAI	118
SIAREM	127
SICATEL	121
SIEMENS	018,059,060,061
SIGNATURE	006,040
SILVER	017
SIMPSON	057,058
SINGER	127
SINUDYNE	049
SKANTIC	099
SKY	018
SOGERA	098
SOLAVOX	016
SOLAVOX	042
SONITRON	108
SONOKO	004,018,071
SONOLOR	042
SONTEC	018
SONY	005,017,073,087

Brand	Code
SOUND&VISION	127
SOUNDESIGN	050,051,052,057
SOUNDWAVE	018
SPECTRA	133
SPECTRICON	002
SQUAREVIEW	047
SR2000	106
SSS	009,052
STANDARD	004,063,064,098
STARLITE	052
STERN	042,076,099
SUNKAI	117,118
SUPERTECH	097
SUPRA	025
SUSUMU	064,010,012,014,015, 023,057,058,080
SYMPHONIC	047
SYSLINE	018
TADNDY	124
TANDY	028,030,042,063,064
TASHIKO	110
TASHKO	017,063
TATUNG	002,018,024,028,063, 124
TEC	063,133
TECHLINE	127
TECHNEMA	098
TECHNICS	007,020,021,070
TECHNISAT	130
TECHNOL ACE	051
TECHWOOD	002,021,025
TEKNIKA	006,009,019,023,025, 026,029,036,051,052, 057
TELECO	135
TELEFUNKEN	025

## 14. Manipulating your TV using Remote Control

Brand	Code	Brand	Code
TELEMEISTER	098	VECTRO RESEARCH	015
TELETECH	004	VESTEL	018
TELETON	017,057,063,099	VICTOR	022
TELEVIDEON	098	VIDEOTECHNIC	063
TENSAI	064,093,098,118	VIDEOTON	094
TESLA	135	VIDIKRON	023
TEXET	062,064	VIDTECH	009,017,050
THOMAS	110	VISA	004,005,017,018,042, 068
THOMAS	124	VISION	098
THOMSON	068	VOXSON	042,099
THORN	018,028,040,087,107, 108,110,112,128,129	VTQ	126
TMK	025,049,050	WALTHAM	063,094,099
TOKAI	124	WARDS	006,009,010,011,013, 014,015,023,025,034, 040,043,050,051,058
TOMASHI	075	WATSON	018,098
TOSHIBA	017,026,038,040,069, 106,108	WATT RADIO	097,127
TOSONIC	056	WEGA	017
TOTEVISION	019	WHITE	018,062,098,106
TOWADA	099,127	WESTINGHOUSE	
TRIUMPH	049,069	WORLD-TECH	133
TV TEXT	089	YAMAHA	009,015
UHER	098	YOKO	018,063,071,133
UHER	127	YORK	108
ULTRA	081,124	ZANUSSI	076,099
ULTRAVOX	127	ZENITH	006,007,029
UNIVERSAL	011	ZONDA	002
UNIVERSAL	013		
UNIVERSUM	018,071		

## 15. Menu Map

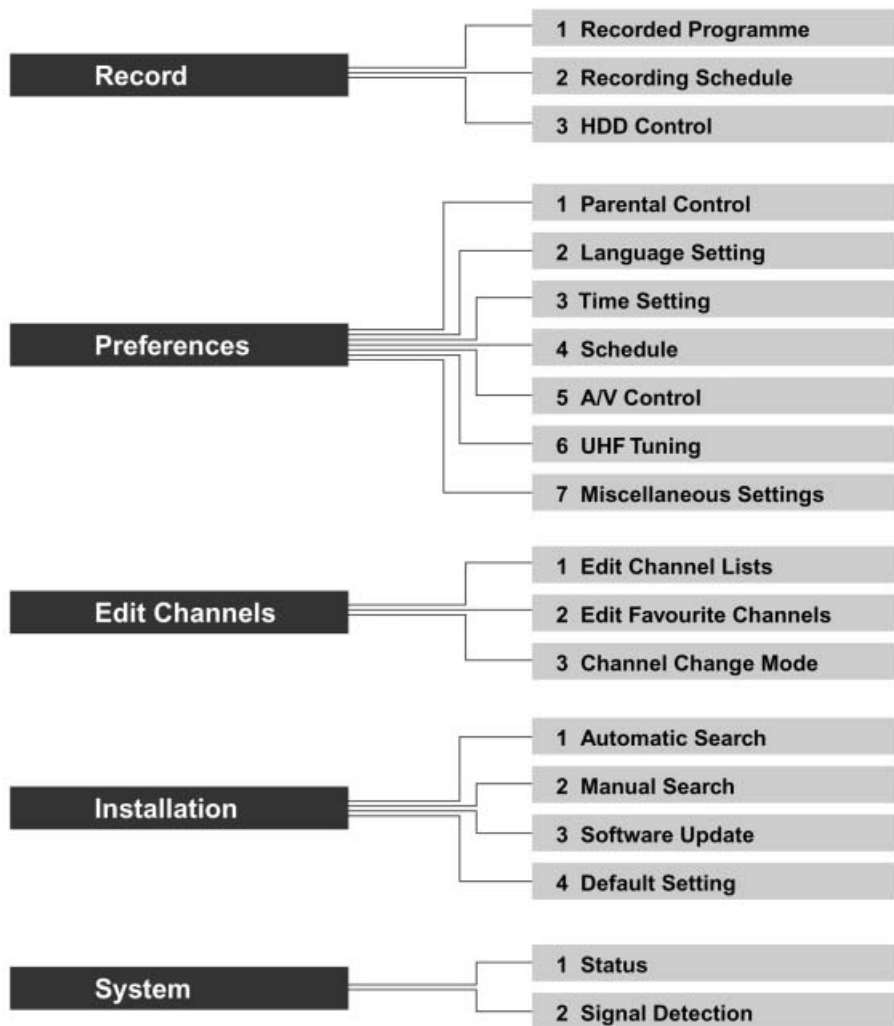

# 16. Trouble Shooting

## 16.1 Trouble Shooting

Before contacting your local service, please make sure following instructions. If the product does not work normally after completing the following trouble shooting, please contact your local product distributor or service centre.

1. No message is displayed on the front panel or product has no power.
  - Check the main power cable and check that it is plugged into a suitable power outlet.
  - Check whether the Power Switch is On.
2. No picture
  - Make sure that the product is in Operation Mode.
  - Make sure that the AV Cable is firmly connected to the TV.
  - Make sure that Aerial line is correctly connected to the equipment.
  - Check the brightness level of TV.
  - Check the channel is on air.
3. Poor picture & sound quality
  - Install the aerial in a place where there is no obstacle.
  - Make sure there is no mobile phone or microwave oven near the equipment.
  - Use 75  $\Omega$  coaxial cable to connecting TV and aerial.
4. No or poor sound
  - Check the volume level of the TV and Receiver.
  - Check the Mute status of the TV and product.
  - Press the Audio button to change the Sound Track type.
5. Remote control does not operate
  - To control the equipment with the remote controller, the remote controller's top end should directly point towards the receiving part of receiver's remote controller.
  - Check the battery of Remote controller.
6. Reservation is not available.
  - Check whether it is not overlapped with other reservation.
  - Check whether the power switch is off.

## 16.2 Error Message

Error message	Possible causes	What to do
No or bad signal	The aerial is not pointing properly.	Adjust aerial. Check the cable from the aerial. If you cannot resolve the problem you may need to have your aerial and installation tested by a professional.
The channel is scrambled or not available.	The channel has signal, but no audio or video. The channel is not deleted by broadcasting company. The channel is for data broadcasting.	Confirm if the channel is currently on air.  Cannot watch the channel in usual way.
The channel is scrambled.	This digital terrestrial receiver does not support the service that enables to descramble the scrambled channels.	
The audio is not available.	The channel has signal, but no Audio.	Press the Audio button to confirm if the channel has Audio.

## 17. Specification

Tuner & Channel	
Tuner Input Connector	IEC-Type, IEC 169-2, Female
RF Loop through Output connector	IEC-Type, IEC 169-2, Male
Frequency Range	48.5MHZ to 226.5MHz (VHF) 470MHZ to 862MHz (UHF)
Signal Level	-10 to -70dBm
Demodulation	OFDM
Mode	2K, 8K
MPEG Transport Stream A/V Decoding	
Transport Stream	MPEG-2 ISO/IEC 13818 Transport Stream Specification
Profile Level	MPEG2 MP@ML
Video Input Rate	15 Mbit/s Max
Aspect Ratio	4:3, 16:9 Letter box
Video Resolution	720 x 576, 720 x 480
Audio Decoding	MPEG/MusiCam Layer I & II
Audio Mode	Single /Dual mono, Stereo, Joint stereo

Memory	
Flash Memory	2 Mbytes
Graphics (MPEG) & System DEAM	16 Mbytes
EEPROM	8 Kbytes
A/V & Data In/Out	
Video	RCA/SCART Video Output(CVBS, RGB, S-video)
Audio R/L	RCA/SCART Volume and Mute Control (Resolution: 20 bits DAC, MAX. 2Vrms)
S/PDIF	Digital Audio Output, Fiber-Optic(Resolution : 20 bits)
RS-232C	Transfer Rate:115,200 bps,3 pin Socket type
Power Supply	
Input Voltage	AC 90 ~ 250V, 50/60Hz
Type	SMPS
Power Consumption	Max. 20 W
Stand by Power	Max. 8.5 W
Protection	Separate Internal Fuse. The input should be protected against lightning.
Physical Specification	
Size	370 mm x 60 mm x 262 mm
Weight (Net)	Around 3.5Kg
Operating Temperature	0 °C to +45 °C
Storage Humidity	-10% ~ + 70% RH(Non-Condensing)

## 18. Glossary

### **Programme Guide (Electronic Programme Guide, EPG)**

A electronic programme guide (EPG) that comes with the broadcast to a particular aerial, Note that every station fills the EPG differently or not, so differences in the EPG are not necessarily receiver errors.

### **Frequency**

The number of cycles or events per one second, which is expressed in the unit of hertz

### **FTA (Free- To-Air)**

An unscrambled broadcast, which you can view without additional payments to a service provider.

### **OSD (On Screen Display)**

The function that displays the information about the monitor that the user needs or has to know on the screen directly. OSD information includes brightness, contrast, tuning, RGB adjustment, and screen size and positions (top, left, width, and height), and so on.

### **OTA (Over The Air)**

Means that software downloads where the manufacturer reserves the right to decide when and where to release them through aerial.

### **SCART**

A 21-pin connector used for connection of this product, VCR and TV. Also called Euroconnector or Peritel connector.

### **S/PDIF (Sony/Philips Digital Interface format)**

Standard format for digital audio output. It outputs audio signals directly as digital audio signals without changing into analog signals because conversion into analog signals can degrade signal quality.

# 19. Service and Support

You can get information such as a troubleshooting guide, software upgrades and product support guide from the following web sites and call center (Hotline).

Please try to contact to your local dealers first when you have any problem.

## Web site and e-mail

### Homepage

<a href="http://www.humaxdigital.com">http://www.humaxdigital.com</a>	English
<a href="http://www.humaxdigital.com/Deutsch/">http://www.humaxdigital.com/Deutsch/</a>	Deutsch
<a href="http://www.humaxarabia.com">http://www.humaxarabia.com</a>	Arabic

### HCSA (Humax Customer Service Area)

Software Download, Information and Technical Q&A

<a href="http://www.humaxdigital.com/hcsa/">http://www.humaxdigital.com/hcsa/</a>	English
<a href="http://www.humaxdigital.com/Deutsch/hcsa/">http://www.humaxdigital.com/Deutsch/hcsa/</a>	Deutsch

### E-mail (Technical Q&A)

<a href="mailto:tech-info@humax-digital.co.uk">tech-info@humax-digital.co.uk</a>	Europe & North Africa
<a href="mailto:techinfo@humax-digital.de">techinfo@humax-digital.de</a>	Germany
<a href="mailto:callcenterME@humaxdigital.com">callcenterME@humaxdigital.com</a>	Middle East
<a href="mailto:Webmaster@humaxdigital.com">Webmaster@humaxdigital.com</a>	Asia & Other area

# 19. Service and Support

## Call Center

### Humax Middle East Call Center (Dubai, UAE)

Tel: +971 (0)4 359 2323 (Open: 9:00 - 20:00 / close on Friday)

E-mail: callcenterME@humaxdigital.com

Open: Local Time in Dubai (GMT+4)

9:00 - 20:00 (Saturday - Thursday, close on Friday)

Support Language: English/Arabic

### Humax Hotline (Germany)

Germany: 01805 778 870 ( €0,12/Min)

Other Countries: + 49 1805 778 870 ( €0,12/Min+ International Call Charge)

Open: Local Time in Germany (GMT+1)

8:00 - 20:00 (Monday - Friday)

8:00 - 18:00 (Saturday)

Support Language: Deutsch/English

### Humax BTCL Hotline (Premiere Model)

Germany: 01805-778900 ( €0,12/Min)

Austria: 0900-900633 ( €0,33/Min)

For hardware repair, please refer to support website. (Homepage or HCSA)

[www.humaxdigital.com](http://www.humaxdigital.com)

HNPVR8100T.100GB/DE