

Digital Video-Recorder

DVR-9900C

User's Manual



HUMAX
EASY DIGITAL

Notice

Copyright (Copyright © 2006 HUMAX Corporation)

Not to be copied, used or translated in part or whole without HUMAX's prior consent in writing except approval of ownership of copyright and copyright law.

Warranty

The warranty does not cover parts which may become defective due to misuse of the information contained in this manual.

Trademarks

Nagravision is a registered trademark of KUDELSKI S.A.

Manufactured under license from Dolby Laboratories.

'Dolby' and the double-D symbol are trademarks of Dolby Laboratories.

"This product incorporates copyright protection technology that is protected by U.S. patents and other intellectual property rights. Use of this copyright protection technology must be authorized by Macrovision Corporation, and is intended for home and other limited viewing uses only unless otherwise authorized by Macrovision. Reverse engineering or disassembly is prohibited."

Thank you for purchasing a HUMAX product. Please read this user's manual carefully to be able to safely install, use and maintain the product at maximum performance. Keep this user's manual next to your product for future reference. The information in this user's manual is subject to change without notice.

Notice

Read this manual carefully and make sure you understand the instructions provided. For your safety, be aware of the following precautions.

Warnings, Cautions and Notes

Warning

Indicates a hazardous situation which could result in serious injury.

Caution

Indicates a situation which could damage the equipment or other apparatus.

Note

Indicates additional information to make the user aware of possible problems and information of any importance to help understand, use and maintain the installation.



To reduce the risk of electric shock, do not remove cover (or back). No user serviceable parts inside. Refer servicing to qualified service personnel.



This symbol indicates **dangerous voltage** inside the product that presents a risk of electric shock or personal injury.



This symbol indicates important instructions accompanying the product.

Safety Warning

This product has been manufactured to comply with international safety standards. Please read the following safety precautions carefully.

Safety Instructions and Precautions

1. MAINS SUPPLY

90-250V AC 50/60Hz Operate this product only from the type of power supply indicated on the marking label. If you are not sure of the type of power supplied to your home, consult your local power company. Disconnect the product from the mains before you start any maintenance or installation procedures.

2. OVERLOADING

Do not overload a wall outlet, extension cord or adapter as this may result in electric fire or shock.

3. LIQUID

The product should not be exposed to liquid of any kind. In addition, no objects filled with liquid should be placed on the apparatus.

4. CLEANING

Disconnect the product from the wall outlet before cleaning.

Use a light damp cloth (no solvents) to dust the product.

5. VENTILATION

The slots on top of the product must be left uncovered to allow proper airflow into the unit. Do not stand the product on soft furnishings or carpets. Do not stack electronic equipments on top of the product.

6. ATTACHMENTS

Do not use any unsupported attachments as these may be hazardous or cause damage to the product.

7. CONNECTION TO THE CABLE TV SIGNAL

Connect all components before plugging any power cords into the wall outlet. Always turn off the product, TV and other components before you connect or disconnect any cables.

8. CONNECTION TO THE TV

Disconnect the product from the mains before connecting or disconnecting the cable from the TV. Failure to do so can damage the TV.

9. LOCATION

- Place the product indoors to avoid exposing it to lightning, rain or sun.
- Do not place it near a radiator or heat register.
- Make sure it has more than 10 cm clearance from any appliances susceptible to electromagnetic influences, such as a TV or a VCR.
- Do not block the openings with any object, and do not place the product on a bed, sofa, rug, or other similar surface.
- If you place the product on a rack or a bookcase, ensure that there is adequate ventilation and that you have followed the manufacturer's instructions for mounting.
- Do not place the product on an unstable cart, stand, tripod, bracket, or table where it can fall.
- A falling product can cause serious injury to a child or adult, and serious damage to the appliance.

Safety Warning

10. LIGHTNING, STORM or NOT IN USE

Unplug the product from the wall outlet and disconnect the antenna during a thunderstorm or when left unattended and unused for long periods of time. This will prevent damage to the unit due to lightning and power-surges.

11. EXTRANEIOUS OBJECTS

Do not insert anything through the openings in the unit, where they can touch dangerous voltage points or damage parts.

12. REPLACEMENT of PARTS

When replacement of parts is required, be sure the service technician uses replacement parts specified by the manufacturer or those that have the same characteristics as the original part. Unauthorised substitution may result in additional damage to the unit.

Warning

- Follow these directions in order to avoid damage of the power cord or plug.
- Do not modify or process the power cord or plug arbitrarily.
- Do not bend or twist the power cord.
- Make sure to disconnect the power cord holding the plug.
- Keep heating appliances as far as possible from the power cord in order to prevent the cover vinyl from melting.
- The main plug shall remain readily operable.

- Follow these directions. Failure to follow any of them may cause electrical shock.
- Do not open the main body.
- Do not insert metal or inflammable objects inside the product.
- Do not touch the power plug with wet hands.
- Disconnect the power cord in case of lightning.

- Do not use the product when it is out of order. If you continue to use the product when defective, serious damage can be caused to it. Make sure to contact your local product distributor if the product is out of order.

- Please do not insert metal or alien substance into the slots for the modules or Smartcards. It may cause damage to the product and reduce its life span.

- Hard Disk Drive
Do not move the product or turn the power off suddenly while the hard disk drive is running. The company shall not be liable for any corruption of data on the hard disk drive caused by the carelessness or misuse of users.

Contents

1. Before Using the Product	GB8
1.1 Package Contents	GB8
1.2 Front Panel	GB9
1.3 Conditional Access	GB10
1.4 Rear Panel	GB11
1.5 Remote Control	GB12
1.6 Inserting Batteries	GB14
2. Setup	GB15
2.1 Connecting the Cable	GB15
2.2 Connecting the TV	GB16
2.3 Connecting the TV and VCR	GB18
2.4 Powering On	GB19
3. Installation Wizard	GB20
3.1 Language	GB20
3.3 Software Update	GB21
3.4 Result	GB21
4. Basic Operation	GB22
4.1 Switching Channel	GB22
4.2 Volume Control	GB22
4.3 Programme Information (i-plate)	GB23
4.4 Option List	GB25
4.5 Pay Per View (PPV)	GB29
5. PVR	GB30
5.1 TSR (Time Shifted Recording)	GB30
5.2 Recording	GB33
5.3 Playback	GB34
6. Channel List	GB35
6.1 Category List	GB35
6.2 Bouquet List	GB36
6.3 Favourite List	GB36
6.4 Alphabet List	GB36
7. Electronic Programme Guide (EPG)	GB37
7.1 Using EPG	GB37
7.2 List Type	GB38
7.3 Recording Using EPG	GB38
7.4 Schedule	GB39
7.5 Finding Programmes	GB41

Contents

8. Service Menu	GB42
8.1 PIN-Code Change	GB42
8.2 Smartcard	GB43
8.3 System	GB43
8.4 Search	GB44
8.5 Picture	GB45
8.6 Dolby Digital	GB46
8.7 Startup Channel	GB47
8.8 Hotlinelist	GB48
9. Record Menü	GB49
9.1 Recorded List	GB49
9.2 Recording Schedule	GB52
9.3 HDD Control	GB53
10. Preferences	GB54
10.1 Language Setting	GB54
10.2 Time Setting	GB56
10.3 A/V Setting	GB58
10.4 Other Settings	GB59
11. Edit Channels	GB60
11.1 Edit Favourite Channels	GB60
12. Installation	GB64
12.1 Automatic Search	GB64
12.2 Linear Search	GB66
12.3 Manual Search	GB67
12.4 Search	GB69
12.5 Factory Reset	GB70
13. Software Update	GB71
13.1 OTA (Over the Air)	GB71
14. Universal Remote Control	GB72
14.1 Universal Setup for Operation with TV Unit	GB72
14.2 Frequently Asked Questions (FAQs)	GB74
14.3 USING THE UNIVERSAL REMOTE CONTROL	GB75
15. Menu Map	GB81

Contents

16. Troubleshooting	GB82
16.1 Trouble Shooting	GB82
16.2 Error Message	GB85
17. Specification	GB86
18. Glossary	GB87
19. Service and Support	GB88

1. Before Using the Product

This chapter provides detail instructions on the product and its accessories.

1.1 Package Contents

Please check all package contents before using your product.



Front Panel



Remote Control

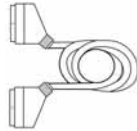

SCART Cable

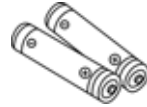

Batteries



User's Manual



RF Cable

Note:

- Faults may occur if the remote control is left without battery for a long time. Always keep the battery inserted in the remote control.
- Package contents may vary according to area.
- A hard disk drive connected to this product will be unusable in a PC by the security policy of operator.

1. Before Using the Product

1.3 Conditional Access

Although some TV and radio channels are free to air, most TV and radio/music channels are available on a subscription basis and can only be enjoyed via a Conditional Access component. The Conditional Access component is a removable Smartcard.

1. Inserting the Smartcard

The Smartcard looks similar to a credit card and is inserted into the slot behind the right-hand front flap of the product. A valid Smartcard entitles you to view and listen to all the channels you choose to subscribe to. The Smartcard slot on the product can be used for Nagravision Smartcard only.

1. Open the right-hand flap on the front panel of the product. Swing it upwards to expose the card slot.
2. Hold the Smartcard horizontally with the electronic chip (small square-shaped, gold in colour) facing upwards.
3. Insert the Smartcard into the slot.

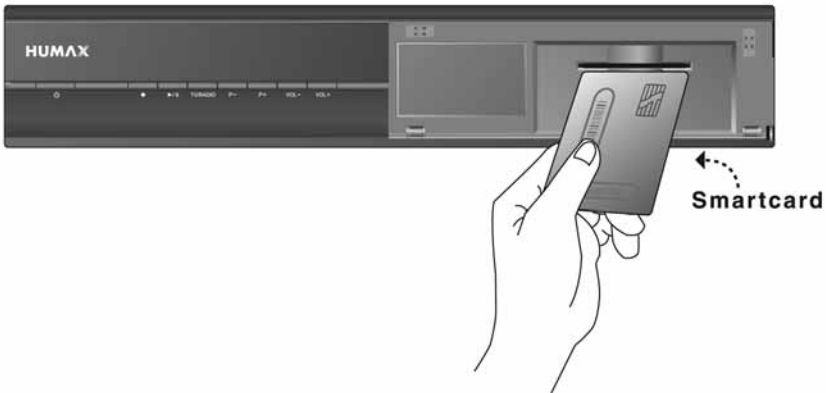

1. Before Using the Product

1.4 Rear Panel

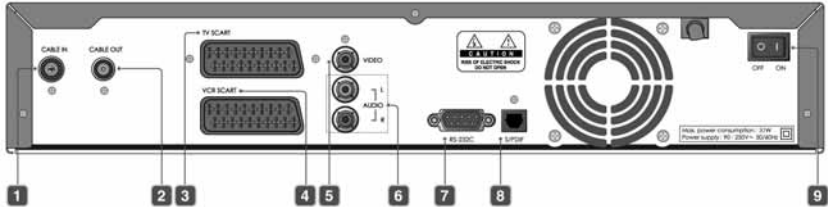

1. **CABLE IN**
Connects a network cable.
2. **CABLE OUT**
Connects to the RF IN of the TV or VCR using a RF cable.
3. **TV SCART**
Connects to the TV using a TV SCART cable.
4. **VCR SCART**
Connects to the VCR or DVD using a VCR SCART cable.
5. **VIDEO**
Connects to the TV or VCR using a VIDEO cable.
6. **AUDIO L/R**
Connects to the TV or VCR using a AUDIO cable.
7. **RS-232C**
Connects to the PC to update software.
8. **S/PDIF**
Connects to the audio system using an S/PDIF cable. (digital audio)
9. **ON/OFF**
Powers on/off.

1. Before Using the Product

1.5 Remote Control



1. KDG

Switches remote control to receiver mode to operate receiver and also exits all menus.

2. TV LED

Lights up when remote control is switched to TV mode and each time pushing a button sends a signal to TV.

1. Before Using the Product

3. **TV**
Switches remote control to TV mode to operate TV.
4. **MUTE**
Audio mute on/off.
5. **TV/Radio**
Switches between TV and radio stations. Switches to AV when in TV mode.
6. **COLOUR BUTTONS**
Select functions displayed in EPG and in station list.
7. **Liste**
Display/hide station list.
8. **EPG**
Display/hide electronic program guide (EPG).
9. **V+/V-** (▲)
Volume level higher/lower.
10. **ARROW BUTTONS**
Navigate in menu, EPG, station list and zapping window (right/left or up/down).
11. **OK**
Confirm selection.
12. **Rec**
Records programme.
13. **FAST REWIND**
Rewinds at high speed. Each time you press this button, the rewind speed is increased.
14. **PLAY/PAUSE**
Plays at normal speed or resumes.
15. **NUMERIC(0-9) BUTTONS**
Enter selection such as PIN number or station number.
16. **Menü**
Display/hide main menu.
17. **STANDBY**
Switches receiver on/off in standby mode.
18. **Opt**
Display options window.
19. **PPV**
Display/hide Pay Per View offerings (if offerings available).
20. **P+/P-**
Switch to next/previous station. Scrolls through pages in station list and EPG.
21. **i (INFORMATION)**
Display zapping window. Display/hide extended program information in zapping window or EPG.
22. **Zurück**
Return to previous menu page or exit menu. Return to station last selected if watching TV.
23. **FAST FORWARD**
Fast forwards at high speed. Each time you press this button, the fast forward speed is increased.
24. **TELETEXT**
Display/hide Videotext (if selected station offers Videotext).

Note: This remote control can also control your TV. To set the remote control for your TV, please refer to **Chapter 14. Universal Remote Control**.

1. Before Using the Product

1.6 Inserting Batteries

Before using the remote control, insert both included AAA batteries as follows:

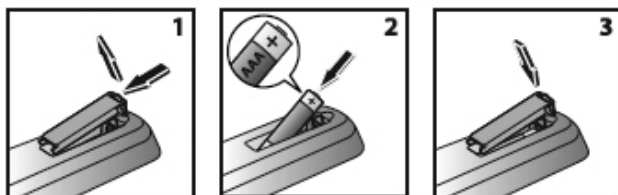

1. Remove the cover.
2. Insert the batteries according to the illustration. Check that the polarity (+/-) is correct.
3. Replace the cover.

Note:

- Do not leave dead batteries in the remote control.
- Always replace the batteries together.
- Dispose of dead batteries in an environmentally-friendly fashion.

2. Setup

This chapter describes how to connect the product to the TV with the particular equipments for gaining optimum signal quality. The product provides various interfaces to connect to the TV, VCR or other devices. Select the most appropriate procedure depending on the equipment you have.

Note: If you encounter any problems setting up your product, please contact your local product distributor.

2.1 Connecting the Cable

Connect your CATV line to the CABLE IN.

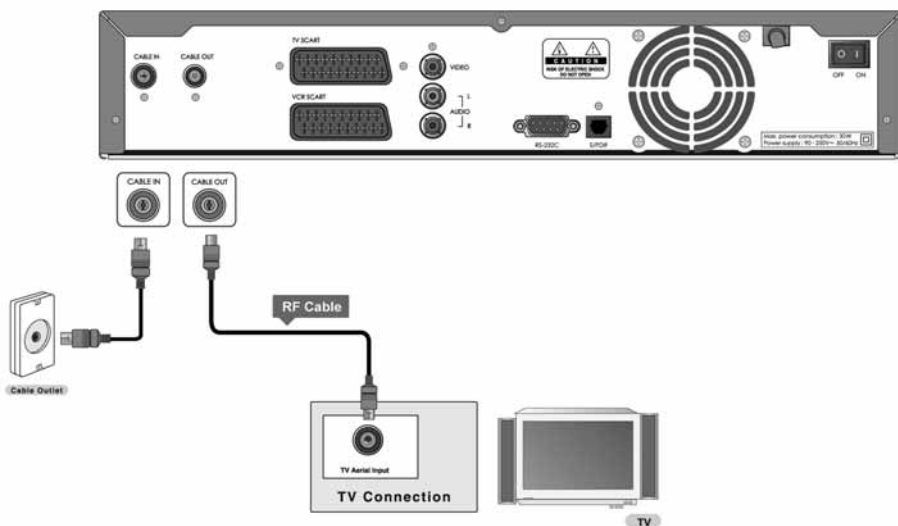

Note: Connect the product and the TV using a RF cable to watch analogue channels.

2. Setup

2.2 Connecting the TV

1. Using SCART Cable

Connect the product and the TV using a SCART cable.

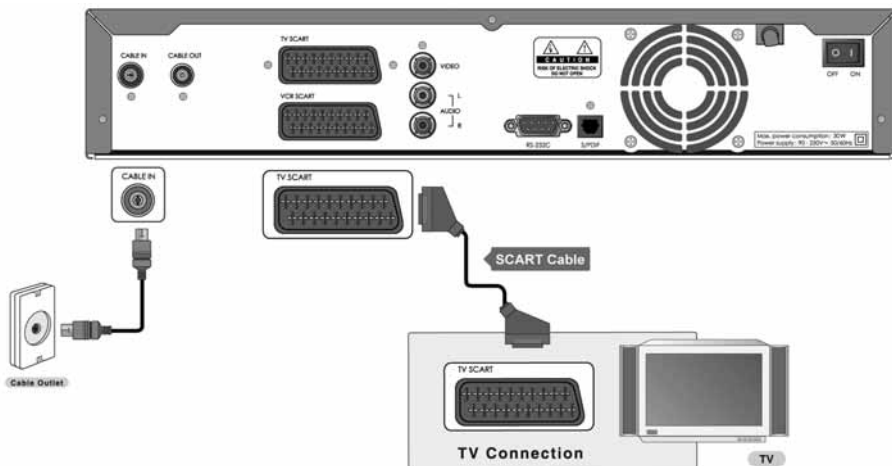

Note: Connecting your TV directly to the audio/video output of the product will assure a more vivid picture and enhance your viewing enjoyment.

2. Setup

2. Using AUDIO/VIDEO Cable

Connect the product and the TV using a AUDIO/VIDEO cable.

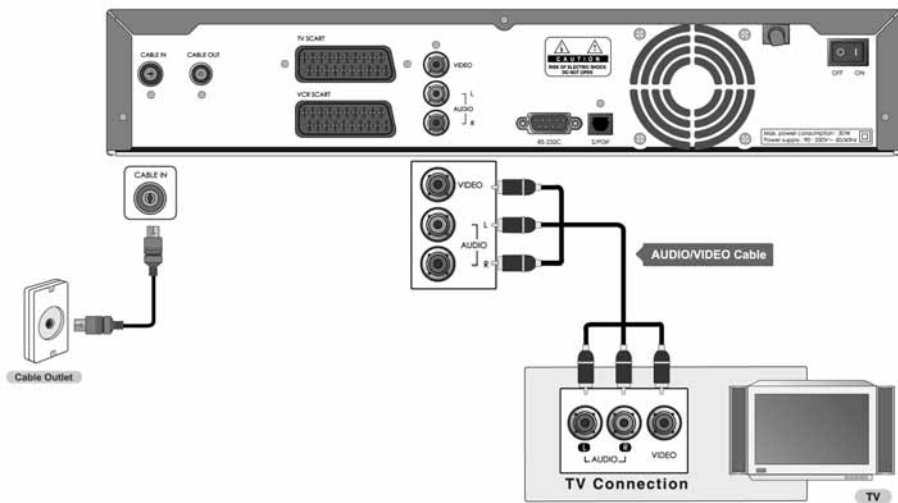

2. Setup

2.3 Connecting the TV and VCR

1. Using SCART Cable

Connect the product and the TV/VCR using a SCART cable.

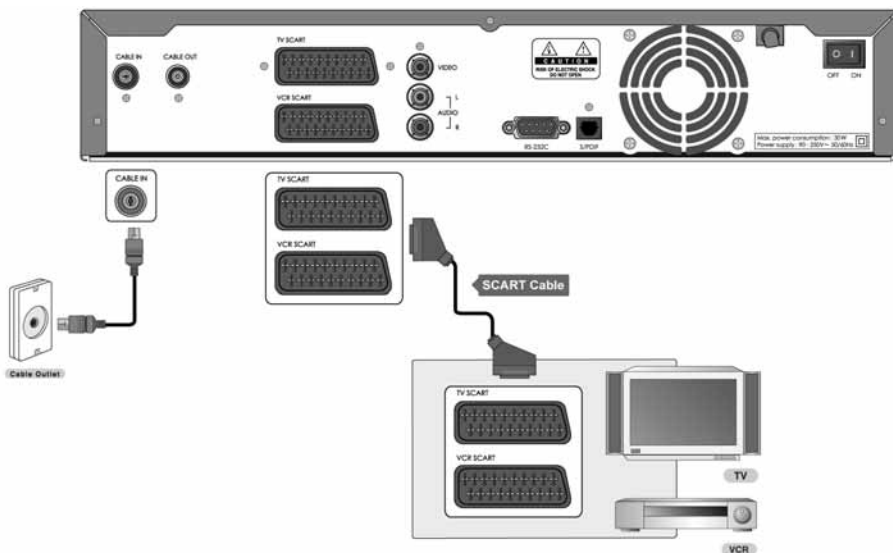

Note: Connecting your TV directly to the audio/video output of the product will assure a more vivid picture and enhance your viewing enjoyment.

2. Setup

2.4 Powering On

1. Connect the power cord of the product to a wall outlet.
2. Turn on the power switch located at the back left of the product.

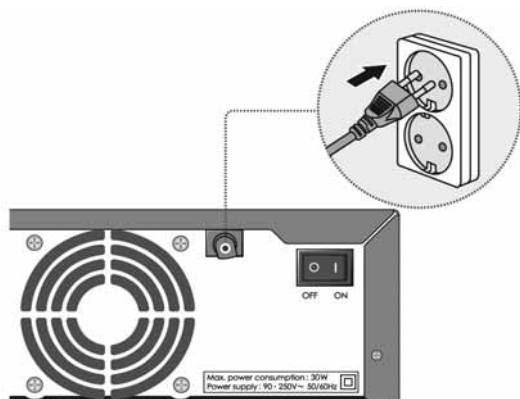

3. Power on by pressing the **STANDBY** (⏻) button of the remote control or the **STANDBY** button at the front of the product.



3. Installation Wizard

When powering on the product for the first time after purchasing, the installation wizard will operate automatically.

You can easily set-up using simple organisation and options, and watch the broadcasting after completing the set-up procedure.

3.1 Language

Select the appropriate language from the list using the ▲/▼ button and press the **OK** (⏏) button to save the selected language as a default language for menu, subtitle and audio.



3.2 Search

You can automatically search channels without entering any other information.

1. Please wait while the search continues.
2. When channel search is complete, the results will appear.



3. Installation Wizard

3.3 Software Update

You can check the current software version and update new software.

1. When new software is detected, a message will pop up to notify that a new software is found.
2. Select **Immediate** and press the **OK** (OK) button to start updating immediately. Select **Later** and press the **OK** (OK) button to update later (stand-by). Select **Refuse** and press the **OK** (OK) button if not needed.
3. Software download starts. Please wait until the update is completed.
4. When software update is complete, the product is automatically powered off and on again.

Note: You can delay the software update up to 3 times when you select **Refuse**.



3.4 Result

The installation wizard is completed.





4. Basic Operation

This chapter describes functions such as switching channel, volume control and basic features for watching programmes.

4.1 Switching Channel



You can switch the current channel using one of the following methods.

1. Press the **P+/P-**  button.
2. Enter the channel number using the **NUMERIC(0-9)** buttons to move to the channel directly.
3. Press the **TV/Radio**  button to switch between TV channel and radio channel.

Note:

- The channel will be switched in the last channel group you have watched. Please refer to **Chapter 6. Channel List**.
- To return to the previous channel, press the **Zurück**  button.
- You can switch channel using the channel list or EPG. For more information, please refer to **6. Channel List** and **7. EPG**.

4.2 Volume Control

1. Press the **V+/V-**  button to adjust the audio volume.
2. Press the **MUTE**  button to stop the audio temporarily.



Note: The mute function remains set while you switch channels.

4. Basic Operation

4.3 Programme Information (i-plate)

Programme information is displayed for a certain period of time whenever you switch channels. You can view the programme information by pressing the **i** (I) or **OK** (OK) button while watching a programme.

1. General Information

General information is displayed as follows on the screen.



1. Channel number and channel name
2. Previous/next channel
3. Detail programme information
4. Programme name
5. Current channel list
6. Current time and date
7. Present/following programme
8. Programme broadcasting time
9. Icons



Displayed only if the programme is recording.



Displayed only if this programme is reserved.



Represents parental level. Indicates the minimum level of age for viewing the programme.



Displayed only when subtitle information is available.



Displayed only when there is any teletext information.



Displayed only when the channel is a scrambled channel.



Displayed only when the programme is broadcast in Dolby Digital.

Select a programme and press the **OK** (OK) button. Then you can record the programme if it is on air or reserve it if it is the future programme.



Note: If there is no programme information available, programme information is not displayed.

4. Basic Operation

2. Detailed Programme Information

You can see the detailed information about the current programme.

Note:

- Press the **i** () button again to hide the information box.
- Press the **Zurück** () button to hide the detailed programme information.
- If the detailed programme information is more than one page, use the **▲/▼** button to move to the previous/next page.











4. Basic Operation

4.4 Option List

You can set options such as audio, multifeed, NVOD, teletext and subtitle language.

1. Audio

You can select the language you prefer in **Audio** if the current programme is available in multiple audio languages.







1. Press the **Opt** () button.
2. Select **Audio** using the  /  button and press the  button.
3. Select the audio language you prefer using the  /  button and press the **OK** () button.
4. Select audio direction (left, right, stereo) using the **OK** () button.

Note: If the programme is broadcast in Dolby Digital, you cannot set the audio direction.



2. Multifeed

You can choose from a choice of camera angles to watch the screen from different camera perspectives while watching a sports transmission. Different options are provided to view single matches or federal league games.





1. Press the **Opt** () button.
2. Select **Multifeed** using the  /  button and press the  button.
3. Select the required option using the  /  button and press the **OK** () button.



4. Basic Operation

3. NVOV (Near Video On Demand)

You can view the start of popular programmes or films within a short period from the time you make your selection. This is possible as the broadcaster sends multiple copies with staggered start times.



1. Press the **Opt** () button.
2. Select **NVOV** using the  button and press the  button.
3. Select the required item using the  button and press the **OK** () button.





4. Basic Operation

4. Teletext

Using Teletext







1. Press the **TELETEXT** () button to display the teletext.
2. To view the teletext page, use the  or **P+/P-** () button.

Describing Teletext Functionality





1. To display teletext menu, press the **Menü** () button in teletext mode.
2. Select the teletext function you want using the  button and press the **OK** () button.



Teletext Functions

- | | | |
|--|--------------------|--|
|  | Index | Returns to index page. If there is no index page, jumps to page 100. |
|  | Sub-page | Searches the sub-page using the sub-code written by users. |
|  | Mix | Adjusts transparency of teletext screen. |
|  | Cancel | Hides the teletext except page number. |
|  | Reveal | Displays the concealed information. |
|  | Double Size | Displays the text size as double size. |
|  | Page Hold | Holds the current page not updating it. |

Selecting the Teletext Language



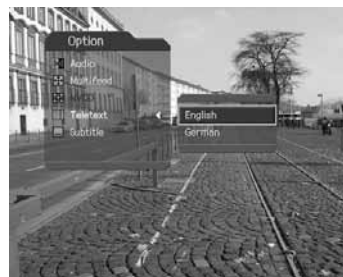





1. Press the **Opt** () button.
2. Select **Teletext** using the  button and press the  button.
3. Select the language you want using the  button and press the () button.



4. Basic Operation

5. Subtitle

You can select the language for the subtitle if the programme provides subtitle information.

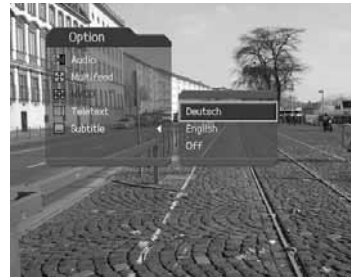

1. Press the **Opt** () button.
2. Select **Subtitle** using the  /  button and press the  button.
3. Select the required subtitle language using the  /  button and press the **OK** () button. The subtitle will be displayed in the selected language at the bottom of the screen.
4. Select **Off** from the subtitle language list and press the **OK** () button to hide subtitle from the screen.



4. Basic Operation

4.5 Pay Per View (PPV)

You can select the programme you want in the Pay Per View (PPV) channel list.

1. Press the **PPV** () button to display the PPV channel list.
2. All functions are similar to those of EPG, refer to **Chapter 7. EPG**.
3. Press the **i** () button in the selected PPV programme to view the detailed information for the selected programme.

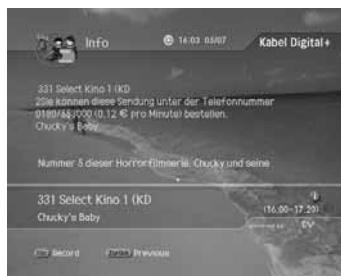

5. PVR

5.1 TSR (Time Shifted Recording)

You can perform TSR (Time Shifted Recording) and other VCR functions within TSR using the playback control buttons while playing a programme. The product automatically saves the programme to the built-in hard disk drive temporarily, so that the users can pause, play, fast rewind, fast forward, etc. even while watching the currently broadcasting TV programme.

1. Time Bar

Press the playback control buttons such as **PLAY/PAUSE** (⏪), **FAST FORWARD** (⏩), **FAST REWIND** (⏮) button while watching a programme to display the time bar. Time bar displays the current operation status, the time gap between the broadcasting point and watching point and the amount of temporarily saved programme.

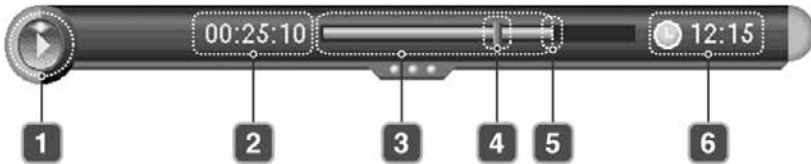

1. Operation status
2. Watching point time
3. Amount of saved programme
4. Watching point
5. Broadcasting (Live) point
6. Current time

2. Play/Pause

1. Press the **PLAY/PAUSE** (⏪) button to pause the current programme.
2. If you press the **PLAY/PAUSE** (⏪) button once again, the programme is resumed from that point.



Note: Pause makes the time gap or delay between the broadcasting (live) point and watching point. The time gap is equivalent to the period the programme has been paused. Operations like slow motion and fast rewind also make the time gap. Press the **KDG** (⊙) button to close the time gap and go to live programme.

5. PVR

3. Fast Rewind

1. Press the **FAST REWIND** (⏮) button to watch missed scenes.
2. Each time you press the **FAST REWIND** (⏮) button, the rewind speed increases in the following sequence: x 4, x10, x 30.
3. If you press the **PLAY/PAUSE** (⏮) button, the fast rewind operation stops and the programme is played at normal speed.



Note: You can fast rewind back to the start point. If you reach the start point while rewinding, the programme is automatically played at normal speed from that point.

4. Fast Forward

1. Press the **FAST FORWARD** (⏭) button to fast forward the programme.
2. Each time you press the **FAST FORWARD** (⏭) button, the speed increases in the following sequence: x 4, x10, x 30.
3. If you press the **PLAY/PAUSE** (⏮) button, the fast forward operation stops and the programme is played at normal speed.





Note: You can use the fast forward operation only when there is a time gap between the current watching point and the broadcasting (live) point caused by previous operations such as pause, slow motion or fast rewind. You can fast forward to the current broadcasting point. If the watching point reaches the broadcasting (live) point, the programme is automatically played at normal speed.

5. PVR

5. TSR Recording

Press the **Rec** () button while TSR is operating to record the current programme immediately. While the time shift operation records the programme temporarily, the recording operation records the programme permanently so that you can playback the recorded file at any time. For more information about recording, refer to **5.2 Recording**.

6. Slow Motion

1. Press the **FAST FORWARD** () button while in the pause mode to play the current programme in slow motion.
2. Each time you press the **FAST FORWARD** () button, the speed decreases in the following sequence: x 1/2, x 1/4, x 1/8.
3. Press the **KDG** () button to stop slow motion and return to normal speed.

5. PVR

5.2 Recording

Using the built-in hard disk drive, you can record a programme without external media devices such as VCRs.

Note:

- Ensure that there is enough free space before recording. If the free space on the hard disk drive is insufficient, recording will stop. Recording a one-hour programme may require up to 2 or 3GB of hard disk space. The space necessary for recording a one-hour programme may be different depending on the programme.
- You can record radio programmes also.
- Pressing the **STANDBY** (⏻) button while recording will not stop the recording. The product will go to standby mode after completing recording.

1. General Recording

Press the **Rec** (⏻) button on the remote control to record the current programme instantly.

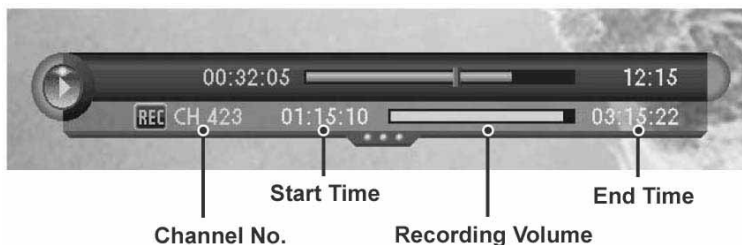

5. PVR

2. Stop Recording

1. Press the **Rec** (Rec) button again. A pop-up will appear. Select **Yes** and press the **OK** (OK) button to stop recording.
2. Change channels while recording and press the **Rec** (Rec) button again. You will be prompted to select one among the options. Select an option using the ▲/▼ button and press the **OK** (OK) button.



5.3 Playback

You can playback the recorded list in the recorded programme menu, refer to **9.1 Recorded List**.

6. Channel List

This chapter will help you display the channel list using the **Liste** (Liste) button and switch to another channel in the channel list.

Four types of channel lists are provided for quick and easy channel search.

- RED:** Category list
- GREEN:** Bouquet list
- YELLOW:** Favourite list
- BLUE:** Alphabet list

6.1 Category List

You can display all channels and subcategories.

1. Press the **Liste** (Liste) button while watching a programme.
2. Press the **RED** button.
3. Select a subcategory you want using the **▲/▼** button and press the **OK** (OK) or **▶** button to display the channel list for the selected subcategory. To hide the channel list, press the **◀** button.
4. Select a channel using the **▲/▼** button and press the **OK** (OK) button to change the channel. Enter the channel number directly using the **NUMERIC(0-9)** buttons to move the cursor to the channel you want. And then press the **OK** (OK) button to change to the selected channel.
5. Select **Recorded List** using the **▲/▼** button and press the **OK** (OK) or **▶** button to display the recorded programmes list. To delete a recorded programme, press the **Opt** (Opt) button. Select **Yes** and press the **OK** (OK) button.

Note:

- Whenever you press the **TV/Radio** (TV/Radio) button while the channel list is displayed, the channel list will switch between TV and radio channel lists.
- Press the **KDG** (KDG) button to exit the channel list.

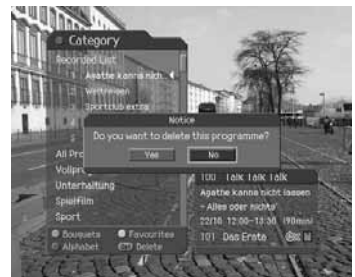

6. Channel List

6.2 Bouquet List

You can display the list of channels classified by bouquet.

1. Press the **Liste** (Liste) button while watching a programme.
2. Press the **GREEN** button.
3. Select **Recorded List** using the ▲/▼ button and press the **OK** (OK) or ► button to display the recorded programmes list.
4. Select a bouquet group you want using the ▲/▼ button and press the ► button to display the channel list for the selected bouquet group. To hide the channel list, press the ◀ button.



6.3 Favourite List

You can display the list of the favourite channels the user has selected. There are five favourite groups in total.

1. Press the **Liste** (Liste) button while watching a programme.
2. Press the **YELLOW** button.
3. Select **Recorded List** using the ▲/▼ button and press the **OK** (OK) or ► button to display the recorded programmes list.
4. Select a favourite group you want using the ▲/▼ button and press the ► button to display the channel list for the selected favourite group. To hide the channel list, press the ◀ button.



6.4 Alphabet List

1. Press the **Liste** (Liste) button while watching a programme.
2. Press the **BLUE** button.
3. Select **Recorded List** using the ▲/▼ button and press the **OK** (OK) or ► button to display the recorded programmes list.
4. Select **All Programme** using the ▲/▼ button and press the **OK** (OK) or ► button to display all channels sorted by alphabet.



7. Electronic Programme Guide (EPG)

The EPG (Electronic Programme Guide) displays the detailed programme information of each channel, in time and date order. You can customize your own EPG to list the channels or programmes of interest to you and schedule your viewing using the programme information.

Note: Press the **STANDBY** (⊙) button to download tvtv EPG data in the standby mode. When download is complete, press the **STANDBY** (⊙) button again to switch to the operation mode.

7.1 Using EPG

You can view programme information by the channel list group.

1. Press the **EPG** (EPG) button.
2. Move to previous/next programme within the same channel using the **◀/▶** button.
3. Move to another channel using the **▲/▼** button. If there are multiple channels, use the **P+/P-** (P+/P-) button to move to channels by page. Also, you can enter channel number you want using the **NUMERIC(0-9)** buttons on the remote control to move to the channel directly.
4. Select a programme and press the **OK** (OK) button. You can record the programme if it is on air or reserve it if it is the future programme.
5. Press the **i** (i) button in the selected programme to view the detailed information for the selected channel.
6. Press the **RED** button to display the category list. Select a subcategory you want using the **▲/▼** button and press the **OK** (OK) button.
7. Press the **FAST REWIND** (⏮) button to moves back to 24 hours before.
8. Press the **FAST FROWARD** (⏭) button to moves forwards to 24 hours ahead.
9. Press the **Opt** (Opt) button to move to 20 o'clock in the evening.



Note: Press the **KDG** (⊙) button to exit the EPG.

7. Electronic Programme Guide (EPG)

7.2 List Type

1. Press the **GREEN** button to switch to the EPG of list type.
2. Move to another channel using the **◀/▶** button.
3. Move to previous/next programme within the same channel using the **▲/▼** button. If the programmes are more than one page, use the **P+P-** button to skip to the next page.
4. Press the **GREEN** button again to return to the EPG of grid type.

Note: The EPG of list type are similar to those of the EPG of grid type, refer to **7.1 Using EPG**.



7.3 Recording Using EPG

1. Select a programme and press the **Rec** (REC) or **OK** (OK) button.
2. You can record the programme if it is on air.
3. If it is the future programme, a pop-up will appear. Select **Yes** and press the **OK** (OK) button to reserve the programme. When a reservation has been completed, the icon **TV** is displayed on the reserved programme. Press the **OK** (OK) button again to cancel reservation.
4. If you select a series programme, a pop-up will appear. Select an option you want using the **▲/▼** button and press the **OK** (OK) button.



7. Electronic Programme Guide (EPG)

7.4 Schedule

You can add or edit recording-reserved programmes using the schedule screen.

1. Press the **EPG** (EPG) button.
2. Press the **YELLOW** button.
3. Select a reserved programme you want to delete using the **▲/▼** button and press the **RED** button.
4. Press the **GREEN** button to return to the EPG of grid type.

1. Adding a Reservation

1. Select a blank space using the **▲/▼** button and press the **OK** (OK) button to add a new reservation.
2. Select **Channel** and **Date** using the **▲/▼** button and press the **▶** button to display channel and date lists. Select an item using the **▲/▼** button and press the **OK** (OK) button.
3. Select **Time** using the **▲/▼** button and press the **NUMERIC(0-9)** buttons to change the time.
4. Select **Repeat** mode among **ONCE**, **DAILY**, **WEEKLY**, **WEEKDAY** and **Series Recording** using the **◀/▶** button.
5. Select **Lock** mode using the **◀/▶** button.
6. Select **Save** and press the **OK** (OK) button to save the changes.
7. Select **Cancel** and press the **OK** (OK) button to cancel the reservation.



7. Electronic Programme Guide (EPG)

2. Editing a Reserved Programme

1. Select a programme you want to edit using the ▲/▼ button and press the **OK** (OK) button.
2. Select **Delete** using the ◀/▶ button and press the **OK** (OK) button to delete the reserved programme. A pop-up will appear. Select **OK** and press the **OK** (OK) button.
3. Select **Edit** using the ◀/▶ button and press the **OK** (OK) button to edit the reserved programme. For more information about how to edit the information, refer to **7.4.1 Adding a Reservation**.

Note: If the reserved programme is overlapped with other programme, adjust the reservation appropriately.



7. Electronic Programme Guide (EPG)

7.5 Finding Programmes

You can sufficiently find the programme you want by programme name.

1. Press the **EPG** (EPG) button.
2. Press the **BLUE** button.
3. Enter the programme name directly using the keyboard displayed on the screen.
4. Select **Find** and press the **OK** (OK) button.

Note:

- Select the **▲/▼/◀/▶** button and then press the **OK** (OK) button to enter the programme name on the keyboard screen.
 - If you select **Previous** or **Next** on the keyboard displayed on the screen and press the **OK** (OK) button, the keyboard layout is switched.
5. Select a programme and press the **Rec** (Rec) or **OK** (OK) button to record or reserve the programme.
 6. If you want to find another programmes, press the **Zurück** (Zurück) or **BLUE** button to display the keyboard screen.

Note: *Found Programme List* may differ depending on the provided programme information.



8. Service Menu

In this chapter you can easily access the service features.

Note:

- Press the **Zurück** (Zurück) or ◀ button to save the changes and return to the previous menu.
- Press the **Menü** (Menü) or KDG (KDG) button to exit the menu screen.

8.1 PIN-Code Change

You can change the current PIN-Code. Enter your new PIN-Code using the **NUMERIC(0-9)** buttons.

1. Press the **Menü** (Menü) button.
2. Select **Service Menu** using the ▲/▼ button and press the **OK** (OK) or ▶ button.
3. Select **PIN-Code Change** using the ▲/▼ button and press the **OK** (OK) or ▶ button.



1. Changing PIN-Code

1. Select the Smartcard of which you wish to change the PIN-Code of.
2. A notice will appear. Read it carefully and press the **OK** (OK) button.
3. Enter your current PIN-Code.
4. Enter your new PIN-Code.
5. Confirm your new PIN-Code.

Note: When changing the PIN-Code, do not repeat the same figures.



2. In case of entering four identical figures

If you enter four identical figures as your new PIN-Code, an error message will appear. You will be prompted to enter another four-digit number as your new PIN-Code.

3. In case of entering a wrong PIN-Code

If you enter the wrong PIN-Code when entering the current PIN-Code, an error message will appear. Access will be denied for 10 minutes if you enter the wrong PIN-Code three times.

8. Service Menu

8.2 Smartcard

1. Press the **Menü** (Menu) button.
2. Select **Service Menu** using the ▲/▼ button and press the **OK** (OK) or ► button.
3. Select **Smartcard** using the ▲/▼ button and press the **OK** (OK) or ► button.
4. The Smartcard information will be displayed.

Note: The displayed information may differ depending on the type of Smartcard.



8.3 System

You can view system information.

1. Press the **Menü** (Menu) button.
2. Select **Service Menu** using the ▲/▼ button and press the **OK** (OK) or ► button.
3. Select **System** using the ▲/▼ button and press the **OK** (OK) or ► button.
4. The system information will be displayed.
5. To perform software update, select **Software Update** and press the **OK** (OK) button.
6. To initialize all settings, select **Reinitialize** and press the **OK** (OK) button.



8. Service Menu

8.4 Search

1. Press the **Menü** (Menu) button.
2. Select **Service Menu** using the ▲/▼ button and press the **OK** (OK) or ► button.
3. Select **Search** using the ▲/▼ button and press the **OK** (OK) or ► button.
4. Select **Start Search of All Program Providers** and press the **OK** (OK) button.
5. Press the **OK** (OK) button and enter the values for **Start Frequency**, **End Frequency**, **Step**, **Constellation** and **Append Symbol Rate**.
6. Press the **OK** (OK) button to activate search.
For more information, refer to **12.1 Automatic Search**.



8. Service Menu

8.5 Picture

You can make settings for picture format, display format, SCART signal and A/V control.

1. Press the **Menü** (Menu) button.
2. Select **Service Menu** using the ▲/▼ button and press the **OK** (OK) or ► button.
3. Select **Picture** using the ▲/▼ button and press the **OK** (OK) or ► button.
4. A notice will appear. Read carefully and press the **OK** (OK) button.



1. Picture Format

You can set the picture format.

Select **Picture Format** using the ▲/▼ button and select from **4:3** and **16:9** using the **OK** (OK) or ► button.

2. Display Format

You can set the display format according to the picture format of your TV.

1. Select **Display Format** using the ▲/▼ button and press the **OK** (OK) or ► button.
2. When choosing **4:3** as picture format, select an option among **Auto**, **Letter Box** and **Center Mode** using the ▲/▼ button and press the **OK** (OK) or ► button.
3. When choosing **16:9** as picture format, select an option among **Auto**, **Pillar Box** and **Full Mode** using the ▲/▼ button and press the **OK** (OK) or ► button.

3. Scart Signal

You can set the SCART signal.

1. Select **Scart Signal** using the ▲/▼ button and press the **OK** (OK) or ► button.
2. Select an option among **CVBS**, **RGB** and **S-Video** using the ▲/▼ button and press the **OK** (OK) or ► button.

4. AV Control

1. Select **AV Control** using the ▲/▼ button and select **On/Off** using the **OK** (OK) or ► button.
2. When you select **Off**, a notice will appear. Read carefully and select **Yes**.

8. Service Menu

8.6 Dolby Digital

You can set Dolby Digital automatically.

1. Press the **Menü** (Menu) button.
2. Select **Service Menu** using the ▲/▼ button and press the **OK** (OK) or ► button.
3. Select **Dolby Digital** using the ▲/▼ button and press the **OK** (OK) or ► button.
4. **Automatic Selection** will appear. Select **On/Off** using the **OK** (OK) or ► button.
5. If you select **On**, the integrated Dolby Digital™ decoder is enable automatically when a Dolby Digital™ programme is received.



7. Service Menu

8.7 Startup Channel

1. Press the **Menü** (Menu) button.
2. Select **Service Menu** using the ▲/▼ button and press the **OK** (OK) or ► button.
3. Select **Startup Channel** using the ▲/▼ button and press the **OK** (OK) or ► button.
4. A notice will appear. Read carefully and press the **OK** (OK) button.



1. Setting the Startup Channel

You can choose to assign a certain channel to be displayed when powering on.

Select **Setting the Startup Channel** using the ▲/▼ button and press the **OK** (OK) or ► button to select **On/Off**.

On The assigned channel will be displayed when powering on.

Off The last channel you have watched will be displayed when powering on.

2. Startup Channel

You can assign a preferred channel as the start channel.

1. Select **Startup Channel** using the ▲/▼ button and press the **OK** (OK) or ► button.
2. Select from **101** and **User preference** using the **OK** (OK) or ► button.
3. When you have selected **User preference**, enter the channel number using the **NUMERIC(0-9)** buttons. Select **OK** and press the **OK** (OK) button.

Note: When **Off** is selected, **Startup Channel** is inactivated.

8. Service Menu

8.8 Hotlinelist

1. Press the **Menü** (Menu) button.
2. Select **Service Menu** using the ▲/▼ button and press the **OK** (OK) or ► button.
3. Select **Hotlinelist** using the ▲/▼ button and press the **OK** (OK) or ► button.
4. The hotlinelist will be displayed.



9. Record Menu

Note:

- Press the **Zurück** (Zurück) or ► button to save the changes and return to the previous menu.
- Press the **Menu** (Menu) or **KDG** (KDG) button to exit the menu screen.

9.1 Recorded List

1. Press the **Menü** (Menü) button.
2. Select **Record Menu** using the ▲/▼ button and press the **OK** (OK) or ► button.
3. Select **Recorded List** using the ▲/▼ button and press the **OK** (OK) or ► button. The recorded programme list appears.

Note:

- The programme being recorded will be added to the recorded programme list after it has been recorded for at least 30 seconds.
- Press the **i** (i) button to view the detailed information of the recorded programme.



1. Deleting Recorded Programmes

1. Select a programme and press the **RED** button to delete a programme from the recorded programme list.
2. Select **Yes** and press the **OK** (OK) button.





9. Record Menu

2. Changing the Attribute

1. Select a programme and press the **GREEN** button to change the attribute of the recorded programme.
2. Select **Programme** using the **▲/▼** button and press the **OK** (**OK**) button to display a keyboard on the screen. Enter the programme name on the keyboard. Select **OK** and press the **OK** (**OK**) button to complete.
3. Select **Protect** using the **▲/▼** button and press the **OK** (**OK**) button to change **Enable/Disable**. You have to enter a password to change the status from **Enable** to **Disable**. **▶** button.
4. Select **Lock** using the **▲/▼** button and press the **OK** (**OK**) button to change **Enable/Disable**. You have to enter a password to change the status from **Enable** to **Disable**.
5. After editing, you have to select **Save** and press the **OK** (**OK**) button to save your changes.



-  Displayed when the recording is stopped because of an unexpected error.
-  Displayed when the channel is protected from deleting and editing.
-  Displayed when the channel is a locked channel.

Note:





- If the protect option of the programme is set to **Enable**, you cannot delete the programme.
- If the lock option of a programme is configured to **Enable**, you have to enter a password to playback the programme.

9. Record Menu

3. Sorting by Time/Name

Each time you press the **BLUE** button, the recorded programmes are sorted by time and name.

4. Playing Recorded Programmes

1. Select programmes you want to playback and press the **OK** () button.
2. The recorded programme will start to play.
3. Press the **P+/P-** () , **KDG** () or **Zurück** () button to stop the current programme and go to live TV.

9. Record Menu

9.2 Recording Schedule

1. Press the **Menü** (Menu) button.
2. Select **Record Menu** using the ▲/▼ button and press the **OK** (OK) or ► button.
3. Select **Recording Schedule** using the ▲/▼ button and press the **OK** (OK) or ► button to display the reserved recording list on the screen.

Note: For more information about how to add or edit a reservation, refer to **7.4 Schedule**.



9. Record Menu

9.3 HDD Control

You can check the free space of the hard disk drive and format (erase) the disk drive if necessary.

1. Press the **Menü** (Menu) button.
2. Select **Record Menu** using the ▲/▼ button and press the **OK** (OK) or ► button.
3. Select **HDD Control** using the ▲/▼ button and press the **OK** (OK) or ► button.
4. You can check the free, used, reserved and total space of the HDD.
5. Select **Format** and press the **OK** (OK) button to remove all the recorded programmes saved on the HDD and initialise the HDD.
6. Select **Yes** when the format confirmation message appears.



Note:

- The format deletes all the recorded programmes saved on the HDD and tvtv EPG information. Formatting does not delete the system files of the product.
- A certain amount of space is reserved for TSR.

10. Preferences

In this chapter you can set language setting, time setting, A/V setting and other configuration items to keep limitations where you want them for the viewers.

Note:

- Press the **Zurück** (Zurück) or ◀ button to save the changes and return to the previous menu.
- Press the **Menü** (Menü) or **KDG** (KDG) button to exit the menu screen.

10.1 Language Setting

1. Press the **Menü** (Menü) button.
2. Select **Preferences** using the ▲/▼ button and press the **OK** (OK) or ▶ button.
3. Select **Language Setting** using the ▲/▼ button and press the **OK** (OK) or ▶ button.



10. Preferences

1. Menu Language

You can choose from the given language options and set the language for the menu.

1. Select **Menu Language** using the ▲/▼ button and press the **OK** (OK) or ► button.
2. Select the language using the ▲/▼ button and press the **OK** (OK) or ► button.



2. Subtitle Display

You can show the subtitles automatically. This service is provided when subtitles are available.

1. Select **Subtitle Display** using the ▲/▼ button.
2. Select from **Auto** and **Manual** using the **OK** (OK) or ► button.

Auto Subtitles are displayed automatically in the predefined subtitle language.

Manual Subtitles are displayed in the language when you select the subtitle language by pressing the **Opt** (Opt) button on the remote control.

3. Subtitle Font

You can select the font of the subtitle.

1. Select **Subtitle Font** using the ▲/▼ button.
2. Select from **Variable** and **Fixed** using the **OK** (OK) or ► button.

Variable Uses the horizontally variable subtitle font.

Fixed Uses the fixed subtitle font.

10. Preferences

10.2 Time Setting

You can set the current time or set the time you want to turn on/off the product.

1. Press the **Menü** (Menu) button.
2. Select **Preferences** using the ▲/▼ button and press the **OK** (OK) or ► button.
3. Select **Time Setting** using the ▲/▼ button and press the **OK** (OK) or ► button.

1. GMT Offset

You can set the GMT offset for current time.

1. Select **GMT Offset** using the ▲/▼ button and press the **OK** (OK) or ► button.
2. Select your GMT offset using the ▲/▼ button and press the **OK** (OK) or ► button. GMT is changed in 30 minutes to 1hour units.

Note: The current time is set automatically whenever GMT offset changes.



2. Power On

You can set the time you want the product to be automatically turned on.

1. Select **Power ON** using the ▲/▼ button.
2. Select **Enable/Disable** using the **OK** (OK) or ► button.
 - Enable** Uses Power On and sets the time the product should be turned on.
 - Disable** Does not use Power On.
3. When you select **Enable**, enter the **Channel No.** and **Time** using the **NUMERIC(0-9)** buttons and press the **OK** (OK) button.



10. Preferences

3. Power Off

You can set the time you want the product to be automatically turned off.

1. Select **Power OFF** using the button.
2. Select **Enable/Disable** using the **OK** (OK) or ► button.

Enable Uses Power Off and sets the time the product should be turned off.

Disable Does not use Power Off.

3. When you select **Enable**, enter the **Time** using the **NUMERIC(0~9)** buttons Then, select **OK** and press the **OK** (OK) button.

Note: Once Power On/Off has been set, it is repeated everyday.



10. Preferences

10.3 A/V Setting

You can set the output of the audio or video.

1. Press the **Menü** (Menu) button.
2. Select **Preferences** using the ▲/▼ button and press the **OK** (OK) or ► button.
3. Select **A/V Setting** using the ▲/▼ button and press the **OK** (OK) or ► button.



1. TV-SCART

1. Select **TV-SCART** using the ▲/▼ button and press the **OK** (OK) or ► button.
2. Select an option among **CVBS**, **RGB** and **S-Video** using the **OK** (OK) or ► button.

2. VCR-SCART

1. Select **VCR-SCART** using the ▲/▼ button.
2. Select from **CVBS** and **S-Video** using the **OK** (OK) or ► button.

3. Audio Output

1. Select **Audio Output** using the ▲/▼ button.
2. Select from **Stereo** and **Mono** using the **OK** (OK) or ► button.

10. Preferences

10.4 Other Settings

1. Press the **Menü** (Menu) button.
2. Select **Preferences** using the ▲/▼ button and press the **OK** (OK) or ► button.
3. Select **Other Settings** using the ▲/▼ button and press the **OK** (OK) or ► button.



1. i Display Time

You can set the automatic display time of the information box when the channel is switched.

1. Select **i Display Time** using the ▲/▼ button and press the **OK** (OK) or ► button.
2. Select a value between **1~20** seconds using the ▲/▼ button and press the **OK** (OK) or ► button.

2. OSD Transparency

You can set the transparency of On Screen Display (OSD).

1. Select **OSD Transparency** using the ▲/▼ button and press the **OK** (OK) or ► button.
2. Select an option among **Disable, 10, 30** and **50** using the ▲/▼ button and press the **OK** (OK) or ► button.

Disable Fully opaque screen

10, 30, 50 The bigger the number, the more transparent the screen.

11. Edit Channels

Note:

- Press the **Zurück** (Zurück) or ◀ button to save the changes and return to the previous menu.
- Press the **Menü** (Menü) or KDG (KDG) button to exit the menu screen.

11.1 Edit Favourite Channels

You can edit favourite channel or favourite channel list.

1. Press the **Menü** (Menü) button.
2. Select **Edit Channels** using the ▲/▼ button and press the **OK** (OK) or ▶ button.
3. Select **Edit Favourite Channels** using the ▲/▼ button and press the **OK** (OK) or ▶ button.
4. You will be prompted to select a favourite group. Select a favourite group to edit using the ▲/▼ button and press the **OK** (OK) button.





The buttons for editing the favourite channel list are described in the following table.



	Remove	Removes from the favourite channel.
	Add	Adds favourite channel.
	TV/RADIO	Switches between TV and radio channel list.
	Fav.Group	Changes favourite channel list group.
	Move	Changes the order of channels within the favourite channel list.
	Rename	Renames the name of favourite channel list.
	Sort	Sorts channels by number or name in all TV/radio channel list.
	Unselect All	Unselects all selected channels.

11. Edit Channels

1. Adding/Removing Favourite Channels

You can add favourite channel(s) to a specific favourite channel list or remove the added favourite channel(s) from the list.







1. Select favourite group using .
2. Select the channel(s) in all TV/radio channel list and press  to add favourite channel(s).
3. Select the channel(s) in favourite channel list and press  to remove favourite channel(s).

Note: You can switch between TV and radio channel list using **TV/Radio**  button or .



2. Moving Favourite Channels

You can change the order of favourite channel(s) in the favourite channel list.





1. Select favourite group using .
2. Select the channel(s) to move within the favourite channel list and press the **OK**  button.
3. Select  and press the **OK**  button.
4. Move the cursor to the location you want using the  button and press the **OK**  button.
5. The selected channel(s) is moved to the location you selected.



11. Edit Channels

3. Renaming Favourite Channel List

You can rename favourite channel list.

1. Select favourite group to rename using  .
2. Select  and press the **OK** () button.
3. Enter favourite channel list name using the keyboard displayed on the screen.
4. When finishing entering favourite channel list name, select **OK** and press the **OK** () button.





11. Edit Channels

4. Additional Features



Additional features provides many useful functions.

Changing between TV and radio channel list



You can add not only TV channel(s) but also radio channel(s) to favourite channel list. Press  to switch all channel list into TV or radio channels.

Note: You can also change to TV or radio channel by pressing **TV/Radio** () button on the remote control.

Selecting Favourite channel list

You can select favourite channel list to edit. Press  to display favourite channel list. Then select the channel list using the  button and press the **OK** () button.

Sorting a channel list

You can sort all TV or radio channel lists by channel number or name for easy favourite channel searching. If channel lists are sorted by channel number,  is displayed. When you press this button, all the channel lists are sorted by name. Or, if channel lists are sorted by channel name,  is switched to . Press this button to order channels by number.

Unselect all the selected channels

Press  to unselect all the selected channels.

12. Installation

In this chapter you can configure the installation settings.

Note:

- Press the **Zurück** (Zurück) or ◀ button to save the changes and return to the previous menu.
- Press the **Menü** (Menü) or KDG (KDG) button to exit the menu screen.

12.1 Automatic Search

Having the product connected to the cable and TV, you can perform automatic search without any additional information necessary.

1. Press the **Menü** (Menü) button.
2. Select **Installation** using the ▲/▼ button and press the **OK** (OK) or ▶ button.
3. Select **Automatic Search** using the ▲/▼ button and press the **OK** (OK) or ▶ button.
4. Enter the values for **Start Frequency**, **End Frequency**, **Step**, **Constellation** and **Append Symbol Rate**.



1. Start/End Frequency

Select **Start/End Frequency** using the ▲/▼ button and press the **OK** (OK) or ▶ button. Enter the frequency using the **NUMERIC(0-9)** buttons.



11. Installation

2. Step

1. Select **Step** using the ▲/▼ button and press the **OK** (OK) or ► button.
2. Select the range of frequency to be increased by each step when activating channel search using the ▲/▼ button and press the **OK** (OK) or ► button. Select **User Define** to enter the value directly. If you do not know the value, select **Auto**.



3. Constellation

1. Select **Constellation** using the ▲/▼ button and press the **OK** (OK) or ► button.
2. Select the constellation using ▲/▼ button and press the **OK** (OK) or ► button. If you do not know the value, select **Auto**.



4. Append Symbol Rate

1. Select **Append Symbol Rate** using the ▲/▼ button and press the **OK** (OK) or ► button.
2. Select a symbol rate using the ▲/▼ button and press the **OK** (OK) and ► button. Select **User Define** to enter the value directly.
3. To delete all entered symbol rates, select **Clear All** using the ▲/▼ button and press the **OK** (OK) and ► button.



12. Installation

12.2 Linear Search

You can search channels by defining the frequency range and other parameters. If you want to search for several channels only, use the linear search instead of manual search.

1. Press the **Menü** (Menu) button.
2. Select **Installation** using the ▲/▼ button and press the **OK** (OK) or ► button.
3. Select **Linear Search** using the ▲/▼ button and press the **OK** (OK) or ► button.
4. Enter the values for **Start Frequency**, **End Frequency**, **Step**, **Constellation** and **Append Symbol Rate**.

Note: **Linear search** are similar to those of automatic search, refer to **12.1 Automatic Search**.



12. Installation

12.3 Manual Search

You can search channels manually using the search parameters.

1. Press the **Menü** (Menu) button.
2. Select **Installation** using the ▲/▼ button and press the **OK** (OK) or ► button.
3. Select **Manual Search** using the ▲/▼ button and press the **OK** (OK) or ► button.
4. Enter the values for **Frequency**, **Symbol Rate**, **Constellation** and **Network Search**.



1. Frequency

1. Select **Frequency** using the ▲/▼ button and press the **OK** (OK) or ► button.
2. Enter the frequency using the **NUMERIC(0-9)** buttons.



2. Symbol Rate

1. Select **Symbol Rate** using the ▲/▼ button and press the **OK** (OK) or ► button.
2. Select the symbol rate using the ▲/▼ button and press the **OK** (OK) or ► button. Select **User Define** to enter the value directly.



12. Installation

3. Constellation

1. Select **Constellation** using the ▲/▼ button and press the OK (OK) or ► button.
2. Select the constellation using ▲/▼ button and press the OK (OK) or ► button. If you do not know the value, select **Auto**.



4. Network Search

Select **Network Search** using the ▲/▼ button. Select **Enable/Disable** using the OK (OK) or ► button.

12. Installation

12.4 Search

1. Select **Search** and press the **OK** (OK) button to activate channel search.
2. Wait until channels search is completed. This may take a few minutes.
3. The cursor is located at **Stop** during channel search. If you press the **OK** (OK) button while performing channel search, the operation will stop and only the channels found so far will be displayed.
4. Reset the settings and activate channel search again if necessary.
5. Select **Save** and press the **OK** (OK) button to save the results.



12. Installation

12.5 Factory Reset

Factory reset restores the product to the default settings.

Warning: Please note that once you perform the factory reset, all data such as the channel list and user configured data are deleted.

1. Press the **Menü** (Menu) button.
2. Select **Installation** using the ▲/▼ button and press the **OK** (OK) or ► button.
3. Select **Factory Reset** using the ▲/▼ button and press the **OK** (OK) or ► button.
4. Select **Yes** and press the **OK** (OK) button to restore all setting to the factory reset. Select **No** and press the **OK** (OK) or **Zurück** (Zurück) button to return to the previous menu.
5. When completing the default setting, the installation wizard will run automatically. For detailed information about the installation wizard, refer to the **Chapter 3. Installation Wizard**.



13. Software Update

In order to maintain proper performance of the product, it is essential to have the most up-to-date software. Visit the Humax website to check the latest news and newly released software versions.

<http://www.humaxdigital.com>.

It is recommended that you periodically check for the availability of software update.

13.1 OTA (Over the Air)

OTA, an abbreviation of **Over-the-Air**, is a standard for the transmission of software through a broadcast system.

The manufacturers reserve the right to decide when and where an update is made available. The new software version is then downloaded via cable. The software update via cable will only occur under the following circumstances.

1. The equipment should have appropriate loader software.

Caution: Please note that if normal loader software is not equipped, the product may not be updated or operate properly after software update.

2. The manufacturer transmits the software via cable. The new version of the software is generally detected automatically.

Caution:

- Please be careful to keep the power on and the power cord plugged in during software update. If the power is off during software update, fatal damage may be caused to the product.
- Please be careful not to pull out the signal line (co-axial cable) during software update. Update may be interrupted and the product may not operate.

Note:

- Other functions will not activate while software update takes place.
- It may take 5 ~10 minutes to update software.
- Scheduling operation cannot work during software update.

14. Universal Remote Control

14.1 Universal Setup for Operation with TV Unit

The **universal remote control** also allows you to operate the most important functions, such as the volume, on your TV.

To be able to use this universal functionality, you must perform a one-time setup of the TV.

The following describes the steps required to set up your TV:

1. Preparing the TV

1. Switch your TV on.
2. In the list of codes at the end of these instructions, search for the 4-digit code number given for the manufacturer of your TV.
If you are unable to find the manufacturer of your TV in the list, use the code number '0000'.

2. Programming the universal remote control



1. Press the **TV** and **Liste** button on the receiver remote control at the same time. Keep both buttons pressed for 5 seconds until the **TV LED** (a small red lamp at the top of the remote control) blinks twice.
2. Enter the 4-digit code number for your TV using the **NUMERIC(0-9)** buttons on your receiver remote control. The **TV LED** is now permanently lit.
3. Then press the **STANDBY** button. Keep the **STANDBY** button pressed until the TV switches off. Release the **STANDBY** button as soon as the TV has switched off.

Note: This process can take several minutes, in some cases up to 15 minutes. During this time, the remote control sends all possible TV signals one after another. Each time a signal is sent by the remote control, the TV LED briefly extinguishes.

14. Universal Remote Control

3. Checking the programming

1. Switch the TV on again and check whether you can operate the most important functions on you TV using the remote control.

Important: You can check all buttons with the exception of the **TV** button.

2. When the TV control functions work properly, press the **TV** button for 3 seconds to confirm this programming.

Note: Your remote control is now ready to operate your TV. The remote control now operates the audio volume level of your TV and not of the receiver. If you want to continue to adjust the volume level of the receiver, press the **KDG** and **MUTE** button for 3 seconds until the **TV LED** blinks twice.

Note: If you cannot operate your TV correctly, switch it on again and repeat points 3 and 4 until the best programming is found.

Important: If in spite of doing so you are not successful, or if you were unable to find the manufacturer of your TV, please look at the remote control web page under (www.kabeldeutschland.de/urc).

4. Restoring the factory setting



Press the **TV** and **0** buttons on the receiver remote control at the same time. Keep both buttons pressed for 5 seconds to allow the remote control to return to its factory settings.

Note: The **TV** button on the remote control has then no function. To be able to again operate your TV with the receiver remote control, you will need to set up the TV from the start.

Note: This process can take several minutes, in some cases up to 15 minutes. During this time, the remote control sends all possible TV signals one after another. Each time a signal is sent by the remote control, the TV LED briefly extinguishes.

14. Universal Remote Control

14.2 Frequently Asked Questions (FAQs)

Topic	FAQ	Answer
Remote control	Can I use the remote control to operate my TV?	Yes, you can operate your TV with the universal remote control after you have carried out a one-time setup.
	Is the remote control teachable?	No, this remote control is not teachable.
	Can I delete the TV settings I have set up?	Yes. Press the TV and 0 buttons at the same time for 3 seconds until the TV LED blinks twice.
	Why does the TV LED blink briefly 6 times when the OK or i buttons are pressed?	This indicates that the batteries must be changed.

14. Universal Remote Control

14.3 USING THE UNIVERSAL REMOTE CONTROL

1. To operate your TV, press the TV button on the receiver remote control. This places it in TV mode and you can control the most important functions on your TV.
2. To be able to operate your receiver, thus returning to normal control, press the **KDG** button.

TV CODE NUMBERS

Manufacturer	Code numbers	Manufacturer	Code numbers	Manufacturer	Code numbers
A.R. Systems	0064	Audiosonic	0036	Carad	0637
Accent	0036	Audioton	0244	Carena	0482
Acec	0039	Audioworld	0725	Carrefour	0063
Acer	9083	Aumark	0087	Carver	0197
Acoustic Research	1323	Autovox	0114	Cascade	0036
Adcom	0652	AVP	1931	Casio	0064
ADL	1244	AWA	0038	Cathay	0064
Admiral	0120	Axxent	0036	CCE	0064
Advent	0903	Axxon	0741	Celestial	0848
Adyson	0244	B&D	1244	Centrum	1064
AEA	0064	Baier	0903	Centurion	0064
AEG	9080	Baird	0136	Century	0114
Agashi	0243	Bang & Olufsen	9045	CGE	0101
AGB	0543	Barco	0579	Cimline	0036
Agef	0114	Basic Line	0401	Cinex	9082
Aiko	0036	Bastide	0244	Citizen	0087
Aim	0064	Bauer	0036	City	0036
Airis	0871	Baur	0036	Clarivox	0445
Aiwa	0732	Bazin	0244	Clatronic	9049
Akai	9030	Beaumark	0205	Clayton	1064
Akashi	0036	Beko	9078	CMS	0243
Akiba	0245	Belson	1218	CMS hightec	0244
Akira	0445	Bennett	0583	Combitech	1935
Akito	0064	BenQ	9071	Concorde	0036
Akura	0064	Beon	0064	Condor	0347
Alaron	0243	Berthen	0695	Conia	0848
Alba	0064	Best	0397	Conrac	9081
Alkos	0062	Bestar	0064	Conrad	0064
Allorgan	0321	Bestar-Daewoo	0401	Contec	0243
Allstar	0064	Binatone	0244	Continental Edison	9043
All-Tel	0892	Black Diamond	1064	Cosmel	0036
Amplivision	0244	Black Panther	0129	Crosley	0114
Amstrad	0036	Black Star	0274	Crown	9042
Anam	0064	Black Strip	0062	Crystal	0458
Anam National	0064	Blackway	0309	CS Electronics	0243
Andersson	9079	Blaupunkt	9021	CTC	0274
Anex	0448	Blue Sky	0064	CTX	1783
Anglo	0036	Blue Star	0309	Curtis Mathes	0087
Anitech	0036	Bondstec	0274	CyberHome	9099
Ansonic	0397	Boots	0244	Cybertron	0245
AOC	1129	Bosch	0347	Cytronix	1325
Apollo	0500	Boxlight	0763	D.Boss	1501
Arc en Ciel	0136	BPL	0064	Daas	0324
Arcam	0243	Brandt	0652	Daewoo	9018
Ardem	0513	Brandt Electroique	0314	Dainichi	0245
Aristona	0583	Braun	9100	Daitsu	1294
Arthur Martin	0190	Brinkmann	9059	Dansai	0064
ASA	0132	Brionvega	0064	Dantax	0397
Asberg	0064	Britannia	0243	Datsura	0235
Asora	0036	Brother	0291	Davis	0763
Astra	0064	Bruns	9044	Dawa	0036
Asuka	0245	BSR	0190	Daytek	9084
ATD	0725	BTC	0245	Dayton	9091
Atlantic	0064	Bush	0695	Daytron	0036
Atori	0036	Canton	0245	de Graaf	0235
Auchan	0190	Capsonic	0291	Decca	0099

14. Universal Remote Control

Manufacturer Code numbers		Manufacturer Code numbers		Manufacturer Code numbers	
Deitron	0064	Euroman	0243	Goldstar	9037
Dell	1291	Europa	0064	Gooding	0514
Denko	0291	Europhon	0064	Goodmans	0661
Denver	0064	Evesham	1275	Gorenje	0397
DER	0220	Excel	0064	GPM	0245
Desmet	0347	Expert	0286	Gradiente	0680
Diamant	0064	Exquisit	0064	Graetz	0741
Diamond	0291	Fagor	0064	Gran Prix	0675
Digatron	0064	FairTec	1218	Granada	0064
Digihome	1176	Family Life	0064	Grandin	0064
Digiline	0064	Fast	9065	Gronic	0129
DigiLogic	0064	Fenner	0401	Grundig	9022
Digitor	0064	Ferguson	0652	Grunkel	1190
Digivision	0388	Fidelity	0190	H&B	0835
DigiX	0907	Filsai	0244	Haier	0725
DiK	0064	Finlandia	0235	Halifax	0291
Dixi	0036	Finlux	9053	Hammerstein	0291
DK digital	1969	Firstline	0064	Hampton	0243
DL	0064	Fisher	0131	Hanimex	0245
DMTECH	1991	Flatdisplays	0901	Hanseatic	9025
Domeos	0695	Flint	0064	Hansol	1463
Domland	0421	FNR	0129	Hantarex	0036
Doric	0376	Force	1176	Hantor	0064
Dream Vision	0700	Forgestone	0220	Harsper	0892
DSE	1583	Formenti	0190	Harwa	1223
DTS	0036	Formenti-Phonenix	0243	Harwood	0036
Dual	9023	Fortress	0120	Hauptpaue	0064
Dumont	0114	Fraba	0064	HCM	0036
Dunai	0571	Friac	0036	Hedzon	0583
Durabrand	0064	Frontech	0274	Hema	0244
Dux	0064	Fujimaro	0892	Hemmermann	0376
D-Vision	0064	Fujitsu	0099	Hicon	1494
Dynatron	0064	Fujitsu General	0036	Hifivox	0136
Easy Living	1275	Fujitsu Siemens	9040	Higashi	0243
Edison-Minerva	0514	Funai	0695	Highline	0291
Eiki	0762	Futronic	0291	Hikona	0245
Elbe	0286	Future	0064	Hinari	0235
Elbe-Sharp	0543	Galaxi	0129	Hisawa	0309
Elcit	0114	Galaxis	0397	HiSense	1390
Elekta	0036	Galeria	0036	Hit	0114
Elfunk	1235	GBC	0579	Hitachi	9016
ELG	0064	GE	0370	Hitachi Fujian	0135
Elin	0243	Geant Casino	0190	Hitsu	0036
Elite	0245	GEC	0190	HMV	0114
Elman	0129	Geloso	0274	Höher	0741
Elta	9057	General	0136	Home Electronics	0633
Emco	0274	General Electric	0370	Hornyphon	0064
Emerson	0741	General Technic	0036	Hoshai	0245
Emperor	0309	Genesis	0036	Huanyu	0401
Epson	9077	Genexxa	0245	Hugoson	0917
Erres	0064	Gericom	9060	Humax	1322
ESC	0064	Gevalt	1398	Hygashi	0244
Estèle	0579	Giant	0244	Hyper	0036
Etron	0064	G-Luxon	0871	Hypersonic	0388
Eurofeel	0291	Goldfunk	0695	Hypson	0064
EuroLine	0064	Goldhand	0243	Hyundai	9038

14. Universal Remote Control

Manufacturer Code numbers		Manufacturer Code numbers		Manufacturer Code numbers	
Iberia	0064	Kneissel	0064	Marelli	0114
ICE	0291	Kobra	1494	Mark	0064
Ices	0245	Kolster	0064	Master's	0526
Icos	0039	Konichi	0036	Masuda	0245
Ict	0064	Konka	0064	Matsui	0064
IlSonic	1403	Kontakt	0514	Matsushita	0677
Iiyama	1244	Korpel	0064	Matsuyama	0614
Imperial	9036	Korting	9067	Maxam	0291
Indesit	0264	Kosmos	0064	Maxim	2009
Indiana	0064	Kotron	0291	MAXIVIDEO	0341
InFocus	9072	Koyoda	0036	MCE	0036
Ingelen	9041	Kriesler	0039	Mediator	0064
Ingelen (HB)	9041	KTV	0244	Media Vision	1418
Ingersoll	0036	Kuba	0376	Medion	9020
Inno Hit	0036	Kuba Electronic	0330	Megas	9068
Innovation	0546	Kyoshu	0445	Megatron	0205
Innowert	9085	Kyoto	0190	MEI	1064
Interactive	0064	L&S Electronic	9076	Meletronic	9033
Interbuy	0036	LaSAT	0513	Memorex	0036
Interfunk	0064	Lava	1501	Memphis	0099
Internal	0064	Leader	0036	Mercury	0064
International	0243	Lecson	0064	Merritt	0575
Intervision	0309	Legend	0036	Metz	9019
Irradio	0036	Lemair	0438	MGA	0205
Isukai	0245	Lenco	9054	Micromaxx	0064
ITC	0244	Lenoir	0036	Microstar	0835
ITS	0064	Lesa	0274	Mikomi	1176
ITT	0190	Levis Austria	0064	Minato	0064
ITT Nokia	0388	Lexsor	1223	Minerva	0514
ITV	0291	Leyco	0291	Minoka	0064
JDV	2009	LG	9014	Mirror	1927
Jean	0063	Liesenk & Tter	0354	Mistral Electronics	0220
JEC	0062	Liesenkotter	9086	Mitsubishi	0135
JMB	0064	Lifetec	9035	Mitsuri General	0190
JNC	1991	Lloyd's	0036	Mivar	0319
Jocel	0739	LME	0458	Monaco	0036
Jouge	1462	Lodos	1064	Morgan's	0064
Jubilee	0583	Loewe	9007	Motorola	0120
JVC	9008	Logik	0038	MTC	0087
Kaisui	0245	Logix	0695	MTlogic	0741
Kambrook	0458	Luker	2009	Multibroadcast	0220
Kamp	0243	Luma	0064	Multimat	0341
Kapsch	0190	Lumatron	0064	Multistandard	0129
Karcher	9052	Lux May	0064	Multitec	0064
Kathrein	0583	Luxman	0606	Multitech	0376
Kawa	0398	Luxor	1190	Murphy	0131
Kawasho	0243	LXI	0205	Musikland	0064
KB Aristocrat	0190	Madison	0064	MyCom	1403
Kendo	9050	Magnadyne	0114	Myrrad	0583
Kennedy	0190	Magnafon	0543	NAD	0193
Kennex	1064	Magnavox	0064	Naiko	0064
Kenwood	0132	Magnum	9032	Nakimura	0401
KIC	0244	Mandor	0291	Naonis	0190
Kingsley	0243	Manesth	0064	Narita	2009
Kiss	0827	Manhattan	9062	NAT	0253
Kiton	0583	Marantz	0064	National	0253

14. Universal Remote Control

Manufacturer Code numbers		Manufacturer Code numbers		Manufacturer Code numbers	
Nec	9051	Papouw	0064	Realistic	0205
Neckermann	0064	Pathe Cinema	0190	Recor	0064
NEI	0064	Pathe Marconi	0136	Rectiligne	0064
Neovia	1233	Pausa	0036	Rediffusion	0388
Nesco	0274	Perdio	0099	Redstar	0064
Netsat	0064	Perfekt	0064	Reflex	0064
Neufunk	0064	Philco	0114	Relisys	0892
New Tech	0064	Philex	0220	Reoc	0741
New World	0245	Philharmonic	0244	Revox	0064
Nfren	0827	Philips	9001	Rex	0438
Nicamagic	0243	Phocus	9074	RFT	9039
Nikkai	0099	Phoenix	0064	Rhapsody	0243
Nikkei	0741	Phonola	0064	Ricoh	0064
Nikko	0205	Pilot	0583	Rinex	0445
Nishi	0509	Pioneer	9031	R-Line	0064
Nobliko	0129	Pionier	0397	Roadstar	9056
Nogamatic	0136	Plantron	0064	Robotron	0114
Nokia	9026	Playsonic	0741	Rodex	0064
Nordic	0244	Policom	0595	Rover	0063
Nordmende	9022	Polytron	0309	Rowa	0291
Norfolk	0190	Poppy	0036	Roxy	0475
Normerel	0064	Portland	0401	Royal Lux	0448
Novak	0039	Powerpoint	0514	Rukopir	0583
Novatron	0064	Prandoni-Prince	0274	Saba	9017
Novita	1411	Precision	0244	Sagem	9087
Nurnberg	0190	Premiere	0036	Saisho	0262
NU-TEC	0482	Prima	0036	Saivod	0064
Oceanic	0190	Princess	0725	Saka	0190
Odeon	0291	Prinston	1064	Sakyno	0482
Okano	0397	Prinz	0099	Salora	0376
Omega	0291	Profex	0036	Salsa	0362
Omni	0725	Profi	0036	Sambers	0543
Onwa	0398	Profitronic	0064	Samsung	9009
Opera	0064	Proline	0064	Sandra	0243
Optimus	0677	Prosonic	9094	Sansui	0064
Optonica	0120	Protech	0064	Santon	0036
Orbit	0064	Proton	0205	Sanyo	9046
ORcom	1531	Provision	0526	Save	0064
Orion	9028	Proxima	0764	Saville	1935
Orline	0064	PVision	1218	SBR	0064
Ormond	0695	Pye	0064	Schaub Lorenz	9034
Orsowe	0543	Pymi	0036	Schneider	9012
Osaki	0099	Quadral	0245	Scotland	0190
Osio	0064	Quasar	0274	Scott	1216
Oso	0245	Quelle	0064	Sears	0205
Osume	0184	Questa	0063	Seaway	0661
Otto Versand	1532	Radialva	0136	Seelver	0583
Pace	1935	Radiola	0064	SEG	9013
Pacific	0064	Radiomarelli	0114	SEI	0114
Packard Bell	1341	RadioShack	0064	Sei-Sinudyne	0129
Pael	0243	Radiotone	0036	Seleco	9088
Palladium	9024	Rafena	0324	Sencora	0036
Palsonic	0291	Rank	0097	Sentra	0303
Panama	0036	Rank Arena	0063	Serino	0637
Panasonic	9004	RBM	0097	Sharp	9011
Panavision	0064	RCA	0652	Sherwood	1426

14. Universal Remote Control

Manufacturer Code numbers		Manufacturer Code numbers		Manufacturer Code numbers	
Shintoshi	0064	Supra	0205	Thomson	9003
Shivaki	0064	Susumu	0362	Thorn	0135
Shorai	0321	Sutron	0036	Thorn-Ferguson	0131
Show	0445	Swissline	0274	Tiny	1223
Siarem	0579	Swisstec	1531	TMK	0205
Siemens	9027	Sydney	0243	Tobishi	0245
Siera	0064	Symphonic	1931	Tokai	0099
Siesta	0397	Sysline	0064	Tokaido	1064
Silva	0064	Sytong	0243	Tokyo	0243
Silva Schneider	1583	T+A	0474	Tomashi	0309
Silver	0063	Tandberg	0394	Tongtel	0614
SilverCrest	1064	Tandy	0245	Topline	1064
SIM2 Multimedia	1324	Targa	0729	Toshiba	9015
Singer	0036	Tashiko	0063	Towada	0376
Sinudyne	0114	Tatung	1583	Toyoda	0036
Sky	9064	TCM	9055	Trakton	0036
Skymaster	0132	Teac	0725	Trans Continens	0695
Sliding	0892	TEC	9075	TRANS-continents	0648
SLX	0695	Tech Line	9092	Transonic	0064
Smaragd	0514	Tech Lux	1216	Transtec	0243
Soemtron	0892	Techica	0245	Triad	0064
Sogera	0347	Technema	0347	Trical	0184
Solavox	0388	Technica	2009	Trident	0543
Sonawa	0245	Technics	0677	Tristar	0291
Sonber	0129	Technisat	9063	Triumph	0543
Soniko	0064	Technisson	9090	Tsoschi	0309
Soniq	1494	Technosonic	0064	TVTEXT 95	0583
Sonitron	0235	Techwood	1190	Uher	0064
Sonneclair	0064	Tecnimagen	0583	Ultravox	0114
Sonoko	0064	Tedelex	0244	Unic Line	0064
Sonolor	0235	Teiron	0036	United	9061
Sontec	0064	Teknika	0087	Universal	0064
Sony	9005	Tele System	0903	Universum	9006
Sound & Vision	0129	Teleavia	0136	Univox	0064
Soundesign	0205	Telecor	0064	Utax	0190
Soundwave	0064	Telefunken	9010	V7 Videoseven	9070
Spectra	0036	Telefusion	0064	Vestel	9069
Ssangyong	0036	Telegazi	0064	Vexa	0036
Staksonic	0036	Telemeister	9095	Victor	0680
Standard	0064	Telesonic	0064	Videologic	0245
Starlite	0036	Telestar	0036	Videologique	0243
Stenway	0309	Teletech	9058	Videosat	0274
Stern	0286	Teleton	0244	VideoSystem	0064
Stevison	2009	Televideon	0347	Videotechnic	0243
Strato	0064	Television	0064	Videoton	0190
Strong	1190	Telexa	0129	Vidikron	0129
Stylandia	0244	Temco	0321	Vidtech	0063
Sunic Line	0064	Tempest	0036	Viewpia	9098
Sunkai	0321	Tennessee	0064	Viewsonic	9073
Sunstar	0398	Tensai	0131	Visiola	0243
Sunwatt	0482	Tenson	0347	Vision	0064
Sunwood	0064	Tesla	0064	Vistar	0303
Superla	0543	Tevion	9029	VMS	0341
Supersonic	0235	Textet	0244	Vortec	0064
SuperTech	0036	ThemeScene	0914	Voxson	0114
Superton	0458	Thomas	1931	Waltham	9048

14. Universal Remote Control

Manufacturer Code numbers	
Watson	9047
Watt Radio	0129
Wega	9096
Wegavox	0036
Welltech	0741
Weltblick	0064
Weston	0064
Wharfedale	0064
White Westinghouse	0347
Windsor	0695
Windstar	0309
Windy Sam	0583
Wintel	0741
World-of-Vision	9066
Worldview	0482
Xenius	0661
XLogic	0725
Xoro	9089
Xrypton	0064
X-View	1218
Yamada	9097
Yamaha	9093
Yamishi	0309
Yokan	0064
Yoko	0244
Yorx	0245
Zanussi	0244
Zenith	0651
Zenor	0366
ZX	1935

15. Menu Map

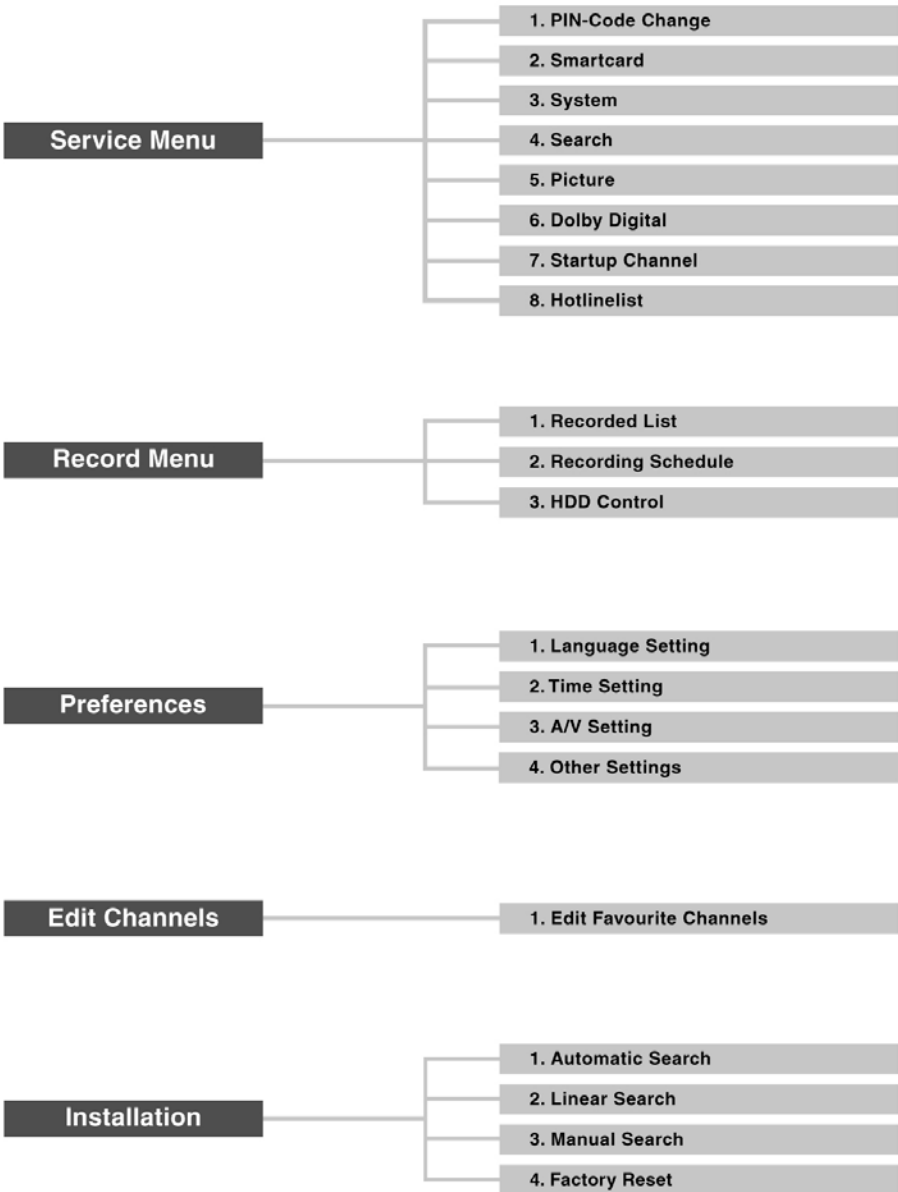

16. Troubleshooting

16.1 Trouble Shooting

Before contacting your local service centre, please read the tips below carefully. If the problem persists after completing the following procedure, please contact your local product distributor or service centre for further instructions.

1. **No message displayed on the front panel.** (The product will not switch on.)
 - Check the main power cable and make sure it is plugged into a suitable power outlet.
 - Check that the mains supply is switched on.
 - Check that the power switch is on at the rear of the product (where applicable).
 - Connect the power cable to a different power outlet.
2. **No picture on TV set**
 - Make sure that the product is power on and in operation mode (Press the STANDBY button).
 - Make sure that the AV cable is firmly connected to the TV.
 - Make sure that the cable is properly connected to the product.
 - Check that you search channels in the menu.
 - Check the brightness level of the TV.
 - Check if the channel is currently on air. Contact the broadcaster to ensure that the channel is running.
3. **No or poor sound**
 - Check that your AV cable is connected correctly.
 - Check the volume levels of your TV set and the product.
 - Check if the product or TV is on mute.
 - Check audio type or soundtrack option in the AV menu.
4. **Cannot make reservations.**
 - Check that no previous reservations are conflicting with the new reservation.
 - Check that the product is switched on at the time of the reservation.
5. **Channel search does not work.**
 - Check that your cable is connected correctly.
6. **Cannot update new software.**
 - You can get an update. If the product does not show a message requesting update, that means no software is available.

16. Troubleshooting

7. **Cannot watch scrambled channels.**

- Check that you have the appropriate Smartcard. Reinsert the Smartcard and make sure it initializes correctly.
- Check in the menu that the product is detecting the Smartcard.
- Check in the menu that you have a valid and working subscription to the channels you wish to view.
- Ensure that the Smartcard is not damaged.

8. **Cannot watch pay channels.**

- Check in the menu that you have a valid and working subscription to the channels you wish to view.
- Contact your network operator for more information.

9. **Cannot record programmes.**

- The hard disk is full. Delete unnecessary programmes and make space for new recording.
- Check if recording is overlapped with another channel. Stop the current recording or wait until the recording is finished.

10. **Cannot operate the TSR.**

- The TSR may not be available during the recording. Wait until the recording is finished.
- Delete unnecessary programmes and make space for new recording.

11. **The product makes a humming noise.**

- The noise is from the fan; the hard disk is operating normally. This kind of noise is inevitable but seldomly noticeable.

12. **Cannot playback.**

- To play back the recorded file of a scrambled channel, use the Smartcard. In case it has been a long time since you last recorded, this may not work. Contact the product distributor.
- The signal during the recording may be weak or the hard disk too full.

13. **Cannot change channel while recording.**

- Certain channels may not be changed due to restriction of the tuner type.

16. Troubleshooting

15. Remote Control

Problem	Potential reason	Recommended solution
Your remote control does not appear to work	The batteries are dead.	Press the KDG button and the i button at the same time for 3 seconds. If the TV LED does not light up, change the batteries.
	The batteries have not been inserted correctly.	Check whether the batteries are inserted correctly.
	You remote control operates the TV.	Press the KDG button to operate the receiver.
	Your remote control operates the receiver only.	Press the TV button to operate the TV.
	The universal remote control is not set up correctly.	Press the TV and 0 buttons at the same time on your receiver remote control to restore the factory settings. Then repeat the programming of the universal remote control from step 1.

16. Troubleshooting

16.2 Error Message

Error message	Possible causes	What to do
No or bad signal	The cable is not connected. The cable may be damaged or defective. The channel is not broadcasting.	Make sure the cable is connected correctly. Exchange the cable.
The channel is scrambled or not available.	The channel has signal, but no video. The channel is deleted by the broadcasting company. The channel is for data broadcasting.	Confirm if the channel is currently on air.
The audio is not available.	The channel has signal, but no audio.	Press the Opt button to confirm if the channel has audio.
No access	No subscription to this channel. No authorization.	Make sure you are subscribed to the channel. If the product has been turned off for a long time (standby or power off), please wait for authorization. It may take up to 60 minutes.
No card inserted.	Smartcard is not inserted.	Insert Smartcard.
Incorrect card	Wrong Smartcard is inserted. Smartcard is not inserted correctly. Smartcard is broken.	Insert appropriate Smartcard. Pull out the Smartcard and reinsert it. Replace the Smartcard.

17. Specification

Tuner and Channel	
Input Connector	IEC 169-2 Female
Frequency Range	47MHz to 862MHz
Signal Level	-15~+15 dBmV
Modulation	QAM
Input Symbol Rate	1.5~7 MS/s

MPEG Transport Stream A/V Decoding	
Transport Stream	MPEG-2 ISO/IEC 13818
Profile Level	MPEG-2 Main Profile @ Main Level
Input Rate	Max 15 Mbps
Aspect Ratio	4:3, 16:9
Video Resolution	720 x 576
Audio Decoding	MPEG/MusiCam Layer I&II
Audio Mode	Single/Dual, Mono/Stereo/Joint Stereo

Memory/Hard Disk Drive	
Flash Memory	4MB
Graphic/System Memory	64MB
EEPROM	8kB
Hard Disk Drive	160G, PATA Interface

A/V & Data In/Out	
Video	RCA/TV SCART/VCR SCART Video Output (CVBS, RGB, S-Video)
Audio R/L	RCA/TV SCART/VCR SCART Volume and Mute Control (Resolution:20bits DAC, Max 2Vrms)
S/PDIF	Digital Audio Output
Data	RS-232C (9pin Male connector)

Power Supply	
Input Voltage	AC 90-250V, 50/60Hz
Type	SMPS
Power Consumption	Max.30W
Protection	Separate internal fuse and lightning protection

Physical Specifications	
Size	380 x 78 x 281 (mm)
Weight	4.5 Kg
Operating Temperature	0°C to + 45°C
Storage Temperature	-10°C to + 70°C

18. Glossary

EPG (Electronic Programme Guide)

An electronic equivalent to a printed television listings magazine; it is an application used with digital set-top boxes and digital television sets to list current and scheduled programs that are or will be available on each channel, including a short summary or commentary for each program. The information supplied in the EPG is sent and updated by the channel broadcaster.

Frequency

The property of a signal measured in cycles per second (=Hz).

OSD (On Screen Display)

OSD displays the basic information necessary for the users to configure monitor or TV settings. OSD information may include brightness, contrast, tuning, RGB adjustment, and screen size and position.

OTA (Over The Air)

A standard for the transmission of software for equipment, through a broadcast system. Manufacturers reserve the right for deciding the release of the software for their products.

SCART

A 21-pin connector standard to connect two pieces of Audio-Visual equipment such as a TV and a VCR. Each device will have a 21-pin female connection; a cable with male connection at both ends is used for connecting the devices.

Smartcard

A chipcard the same size as a credit card which must be inserted into the digital receiver in order to descramble the TV signals.

S/PDIF (Sony/Philips Digital Interface format)

A standard format for the transfer of digital audio signals. It allows the transfer of digital audio between two devices without any conversion to and from analogue, which could degrade the signal quality.

NVOD (Near Video On Demand)

A technology that allows customers to view the start of popular programmes or films within a short period from the time they make their selection. This is possible as the broadcaster sends multiple copies with staggered start times.

PVR (Personal Video Recorder)

Video recorder that can record and play back programmes directly using the embedded hard disk drive(s).

TSR (Time Shifted Recording)

A function that record the present programme temporarily to support trick-play.

HDD (Hard Disk Drive)

The primary computer storage medium, which is made of one or more aluminum or glass platters, coated with a ferromagnetic material.

19. Service and Support

Information concerning troubleshooting, software upgrade and product support is provided in the following websites and call centers.

Should your product require warranty service, please contact HUMAX to obtain the appropriate authorization.

Humax Call Center

Germany

Tel:	01805-778911 (€0,12/min)
Opening Hours:	Mon-Sun 8:00-23:00
E-mail:	support@humax-digital.de
Website:	www.humax-digital.de
Language:	Deutsch/English/Turkish

Austria

Tel:	0820 400675 (€0,12/min)
Opening Hours:	Mon-Sun 8:00-23:00
Website:	www.humax-digital.de
Language:	Deutsch/English/Turkish

Note: For hardware repair, please visit our website.

www.humaxdigital.com



HUMV-DVR9900C.300GB